

Smith V4.1

Fritz Dellsperger

5.2010 / 10.2016 / 1.2018



Content

Impedance Matching	1
Impedance, Admittance, Reflection Coefficient, VSWR and Return Loss	1
Matching arbitrary impedances to 50 Ohm	2
Example 1: Use 2 reactance elements, Highpass	2
Example 2: Use 2 reactance elements, Highpass	3
Example 3: Use 2 reactance elements, Lowpass	4
Example 4: Use 2 reactance elements, Lowpass	5
Example 5: Antenna Match with 3 or more reactance elements, Low Q, Highpass	6
Example 6: Antenna Match with 3 or more reactance elements, Low Q, Lowpass	7
Example 7: Match Ceramic Filter to 50 Ohm	8
Example 8: Antenna match using reactance and serie line element	10
Example 9: Antenna match using serie line and open stub	11
Example 10: Antenna match using serie line and shorted stub	12
Example 11: Antenna match using double stub tuner	13
Example 12: Nonsynchronous Transformer	15
Low Noise Amplifier Design	18
Example 13: Low Noise Amplifier, 2.0 GHz	18
Conjugate Matching	28
Example 14: Conjugate Match	28
Serial Transmission Line with Attenuation	31
Example 15: Match using transmission line with loss	31
Sweeps	32
Example 16: Input impedance of a Chebyshev lowpass filter	32
Example 17: Broadband load match	33
Tune element values	34
Example 18: Match an Antenna with Lowpass network and fixed L-values	34



Impedance Matching

Impedance, Admittance, Reflection Coefficient, VSWR and Return Loss

Impedance: $Z = R + jX$ R: Resistance X: Reactance

$$Z = Z_0 \frac{1 + \Gamma}{1 - \Gamma}$$

Admittance: $Y = G + jB$ G: Conductance B: Susceptance

$$Z = \frac{1}{Y} \quad Y = \frac{1}{Z}$$

Reflection Coefficient: $\Gamma = \frac{Z - Z_0}{Z + Z_0} = \frac{Y_0 - Y}{Y_0 + Y} = |\Gamma| \angle \phi$ Z_0 : Reference Impedance

$$|\Gamma| = \frac{VSWR - 1}{VSWR + 1} = 10^{-\frac{RL}{20}} = \frac{|Z - Z_0|}{|Z + Z_0|}$$

Voltage Standing Wave Ratio: $VSWR = \frac{1 + |\Gamma|}{1 - |\Gamma|} = \frac{1 + 10^{-\frac{RL}{20}}}{1 - 10^{-\frac{RL}{20}}} = \frac{|Z_0|}{|Z|} \Big|_{z < z_0} = \frac{|Z|}{|Z_0|} \Big|_{z > z_0}$

Return Loss: $RL = -20 \cdot \log|\Gamma| = -20 \cdot \log \frac{VSWR - 1}{VSWR + 1} = -20 \cdot \log \frac{|Z - Z_0|}{|Z + Z_0|}$

All values for cursor position in Smith-Chart are displayed in window "Cursor".

Cursor	
Return Loss	20.67 dB
Q	0.12
Y	(17.20+j2.02)mS
Z ₀	50.0Ω
VSWR	1.20 : 1
Γ	0.093 / -38.928 °
Z	(57.34-j6.73)Ω
Freq	999.0MHz



Matching arbitrary impedances to 50 Ohm

Example 1: Use 2 reactance elements, Highpass

Problem: Match an impedance of $(10 + j7)\Omega$ to 50Ω . Use 2 reactance (L,C) in a circuit topology with highpass characteristic. Frequency: 150 MHz.

Smith project file: Example1.xmlsc

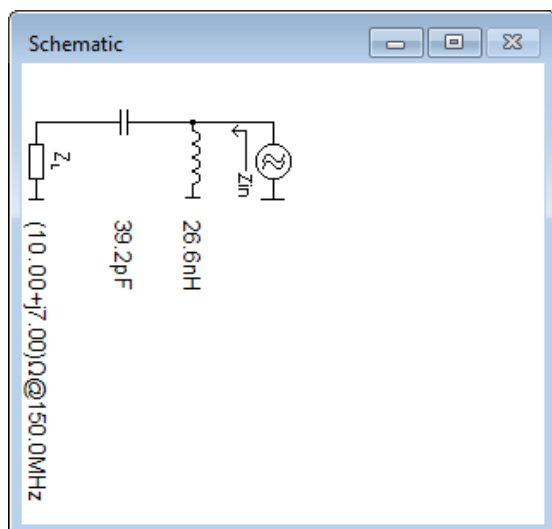
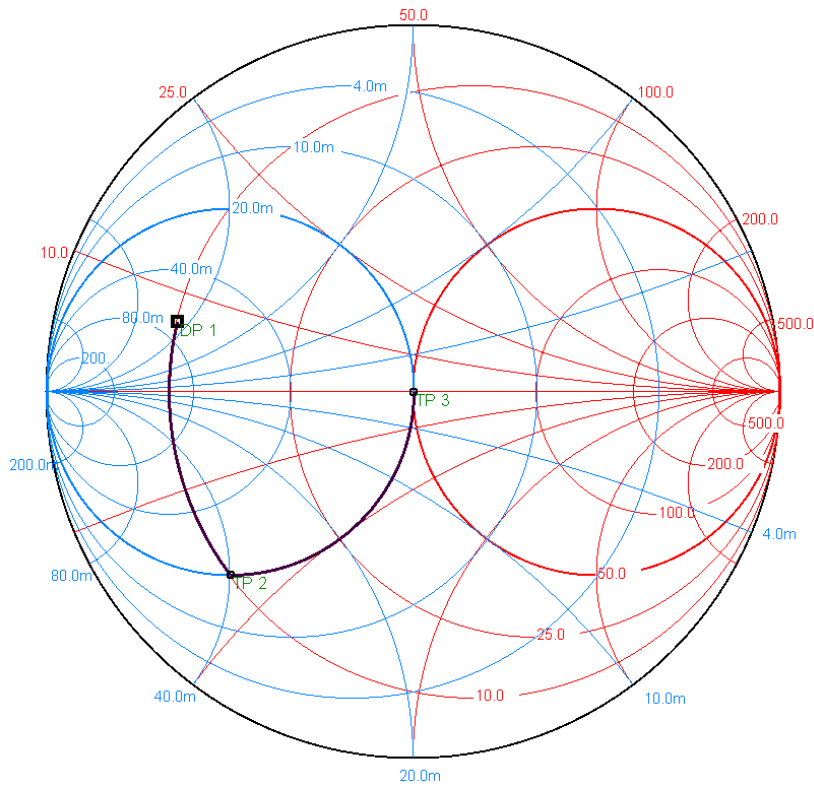

Datapoints

Start DP	Point	Z	Q	Frequency
<input checked="" type="checkbox"/>	DP 1	$(10.000 + j7.000)\Omega$	Q=0.700	150.000MHz
	TP 2	$(10.000 - j20.067)\Omega$	Q=2.007	150.000MHz
	TP 3	$(50.269 - j0.078)\Omega$	Q=0.002	150.000MHz



Example 2: Use 2 reactance elements, Highpass

Problem: Match an impedance of $(100 - j50)\Omega$ to 50Ω . Use 2 reactance (L,C) in a circuit topology with highpass characteristic. Frequency: 500 MHz.

Smith project file: Example2.xmlsc

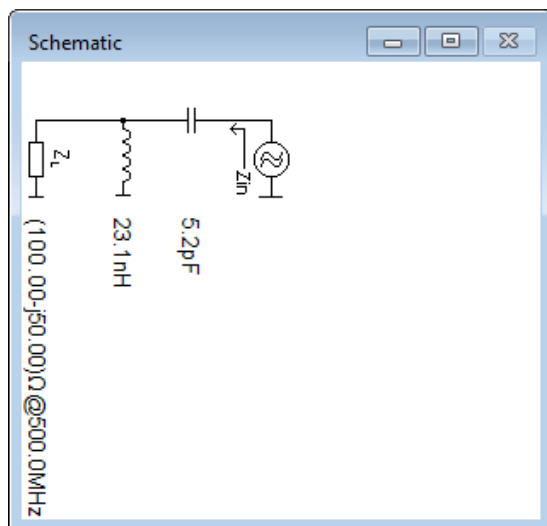
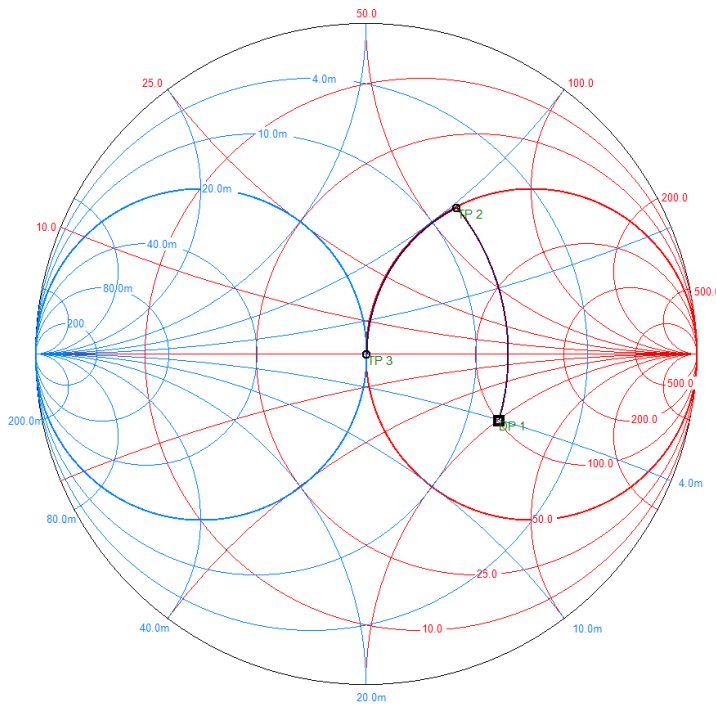

Datapoints

Start DP	Point	Z	Q	Frequency
<input checked="" type="checkbox"/>	DP 1	$(100.000 - j50.000)\ \Omega$	Q=0.500	500.000MHz
	TP 2	$(50.112 + j61.260)\ \Omega$	Q=1.222	500.000MHz
	TP 3	$(50.112 + j0.047)\ \Omega$	Q=0.001	500.000MHz



Example 3: Use 2 reactance elements, Lowpass

Problem: Match an impedance of $(10 + j7)\Omega$ to 50Ω . Use 2 reactance (L,C) in a circuit topology with lowpass characteristic. Frequency: 150 MHz.

Smith project file: Example3.xmlsc

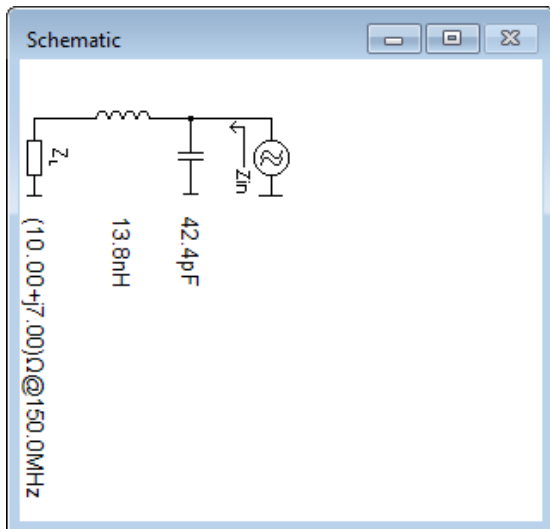
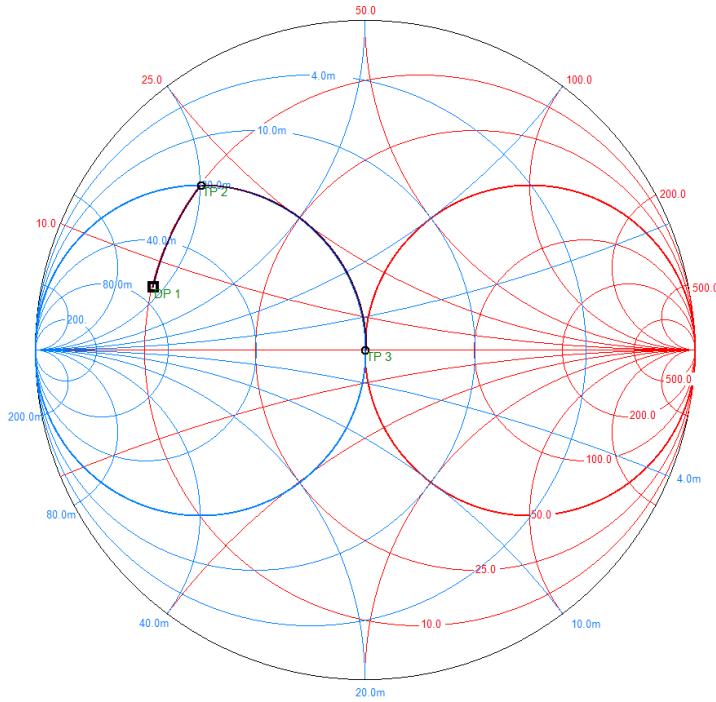

Start DP	Point	Z	Q	Frequency
<input checked="" type="checkbox"/>	DP 1	$(10.000 + j7.000)\Omega$	Q=0.700	150.000MHz
	TP 2	$(10.000 + j20.006)\Omega$	Q=2.001	150.000MHz
	TP 3	$(50.025 + j0.079)\Omega$	Q=0.002	150.000MHz



Example 4: Use 2 reactance elements, Lowpass

Problem: Match an impedance of $(100 - j50)\Omega$ to 50Ω . Use 2 reactance (L,C) in a circuit topology with lowpass characteristic. Frequency: 500 MHz.

Smith project file: Example4.xmlsc

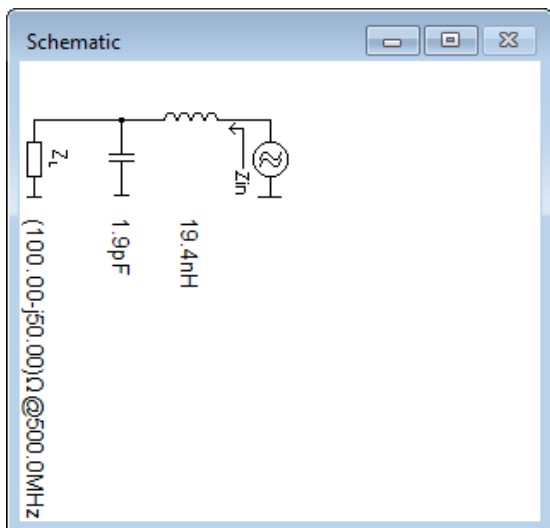
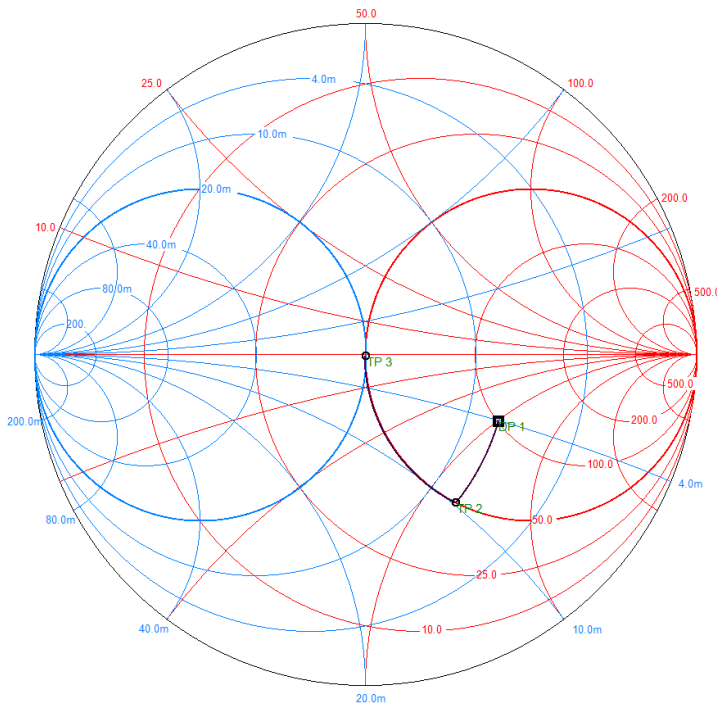

Datapoints

Start DP	Point	Z	Q	Frequency
<input checked="" type="checkbox"/>	DP 1	$(100.000 - j50.000)\Omega$	Q=0.500	500.000MHz
	TP 2	$(49.914 - j61.220)\Omega$	Q=1.226	500.000MHz
	TP 3	$(49.914 - j0.273)\Omega$	Q=0.005	500.000MHz



Example 5: Antenna Match with 3 or more reactance elements, Low Q, Highpass

Problem: Match an antenna impedance of $(20 - j12)\Omega$ to 50Ω . Use L and C in a circuit topology with highpass characteristic and do not exceed a $Q_{\max} = \frac{X}{R} = \frac{12}{20} = 0.6$ (for maximum bandwidth).

Frequency: 450 MHz.

Smith project file: Example5.xmlsc

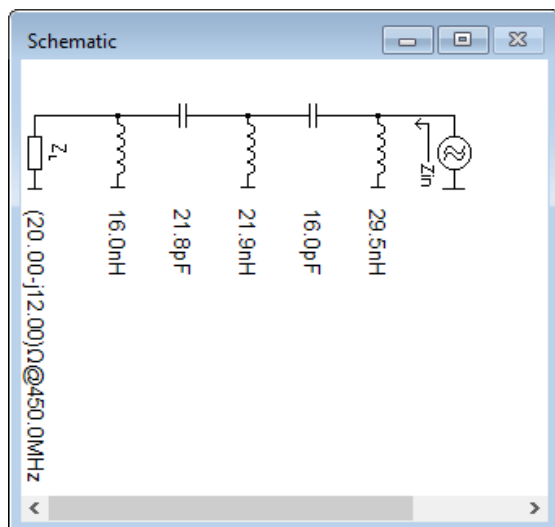
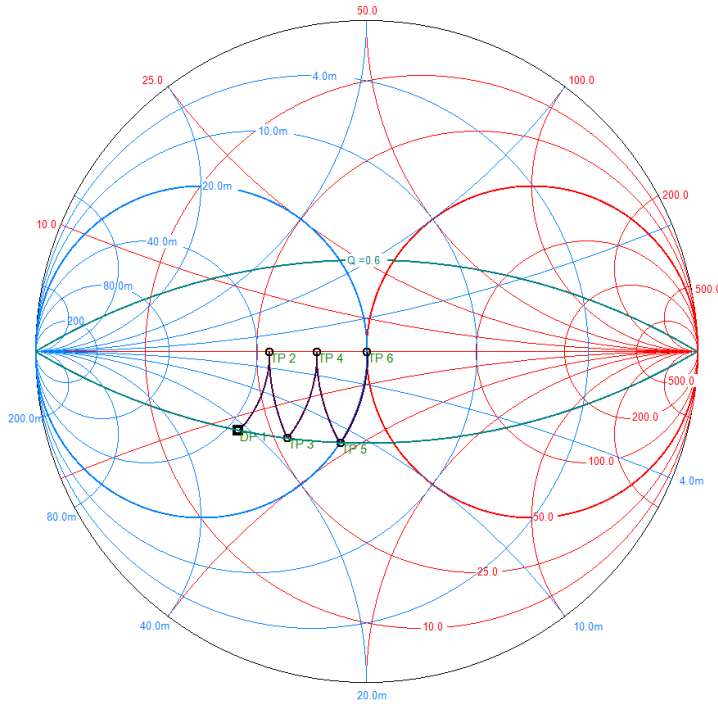

Start DP	Point	Z	Q	Frequency
<input checked="" type="checkbox"/>	DP 1	$(20.000 - j12.000)\Omega$	Q=0.600	450.000MHz
	TP 2	$(27.200 + j0.000)\Omega$	Q=0.000	450.000MHz
	TP 3	$(27.200 - j16.197)\Omega$	Q=0.595	450.000MHz
	TP 4	$(36.845 - j0.000)\Omega$	Q=0.000	450.000MHz
	TP 5	$(36.845 - j22.105)\Omega$	Q=0.600	450.000MHz
	TP 6	$(50.107 + j0.040)\Omega$	Q=0.001	450.000MHz



Example 6: Antenna Match with 3 or more reactance elements, Low Q, Lowpass

Problem: Match an antenna impedance of $(20 - j12)\Omega$ to 50Ω . Use L and C in a circuit topology with lowpass characteristic and do not exceed a $Q_{\max} = \frac{X}{R} = \frac{12}{20} = 0.6$ (for maximum bandwidth).

Frequency: 450 MHz.

Smith project file: Example6.xmlsc

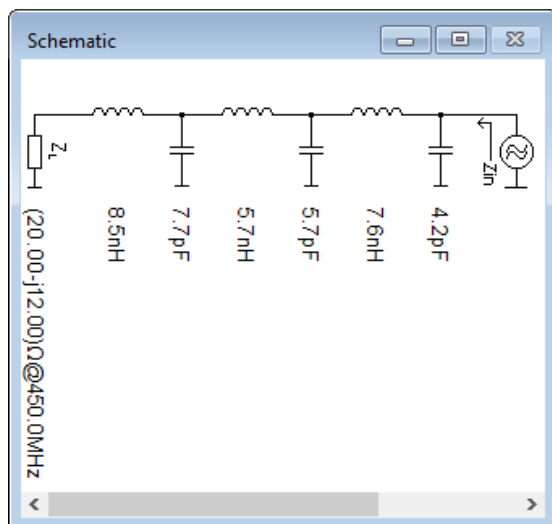
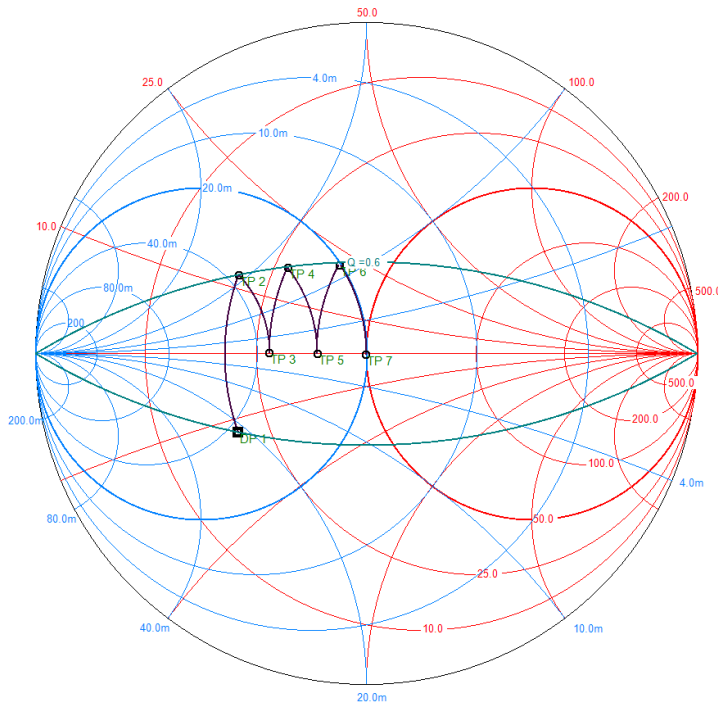

Start DP	Point	Z	Q	Frequency
<input checked="" type="checkbox"/>	DP 1	(20.000 - j12.000) Ω	Q=0.600	450.000MHz
	TP 2	(20.000 + j12.033) Ω	Q=0.602	450.000MHz
	TP 3	(27.238 + j0.235) Ω	Q=0.009	450.000MHz
	TP 4	(27.238 + j16.351) Ω	Q=0.600	450.000MHz
	TP 5	(37.053 + j0.116) Ω	Q=0.003	450.000MHz
	TP 6	(37.053 + j21.605) Ω	Q=0.583	450.000MHz
	TP 7	(49.648 - j0.324) Ω	Q=0.007	450.000MHz



Example 7: Match Ceramic Filter to 50 Ohm

Problem: For measurement purposes match a 10.7 MHz 300 Ohm Ceramic filter to 50 Ohm using a parallel resonance circuit with capacitive voltage divider and $L = 330$ nH.
 Frequency: 10.7 MHz.

Smith project file: Example7.xmlsc

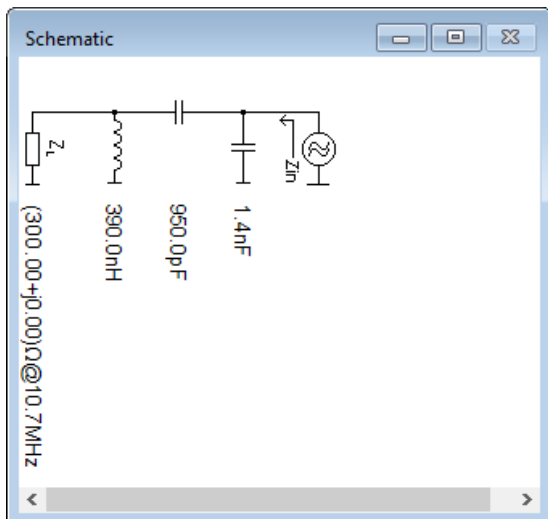
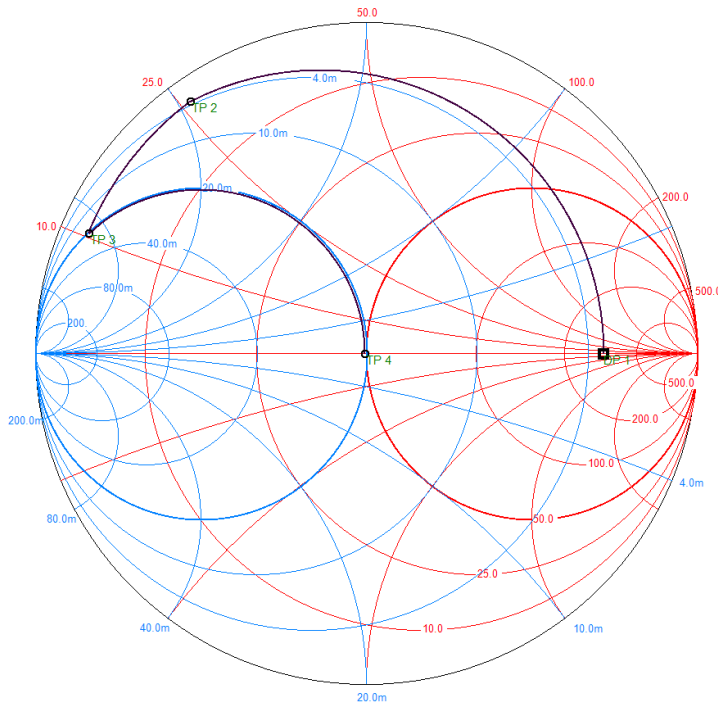

Start DP	Point	Z	Q	Frequency
<input checked="" type="checkbox"/>	DP 1	(300.000 + j0.000) Ω	Q=0.000	10.700MHz
	TP 2	(2.274 + j26.021) Ω	Q=11.442	10.700MHz
	TP 3	(2.274 + j10.364) Ω	Q=4.557	10.700MHz
	TP 4	(49.503 - j0.119) Ω	Q=0.002	10.700MHz



$$f_0 := 10.7 \cdot \text{MHz} \quad R_1 := 300 \cdot \Omega \quad L := 390 \cdot \text{nH}$$

$$B := \frac{2 \cdot \pi \cdot L \cdot f_0^2}{R_1} = 791.298 \cdot \text{kHz}$$

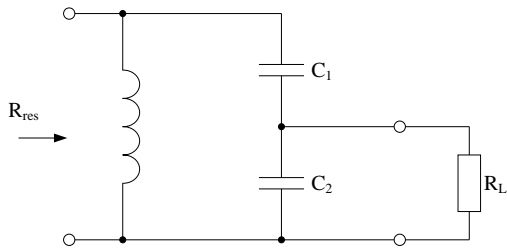

For $Q \geq 10$ following approximations can be used:

$$Q \approx \frac{f_0}{B} \quad C \approx \frac{1}{2\pi B R_{\text{res}}}$$

$$L \approx \frac{1}{\omega_0^2 C}$$

$$N = \sqrt{\frac{R_{\text{res}}}{R_L}}$$

$$Q_p \approx \frac{Q}{N} \quad C_1 \approx \frac{C_2}{N-1}$$

$$C_2 \approx NC$$



Example 8: Antenna match using reactance and serie line element

Problem: Match an antenna impedance of $(30 - j40)\Omega$ to 50Ω . Use one reactance and one serie line. Frequency: 430 MHz.

Smith project file: Example8.xmlsc

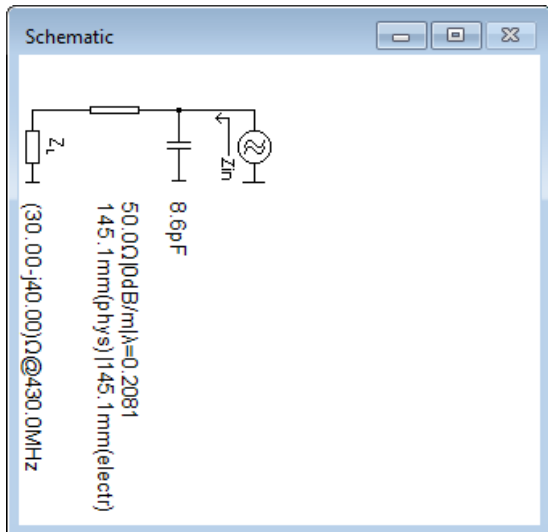
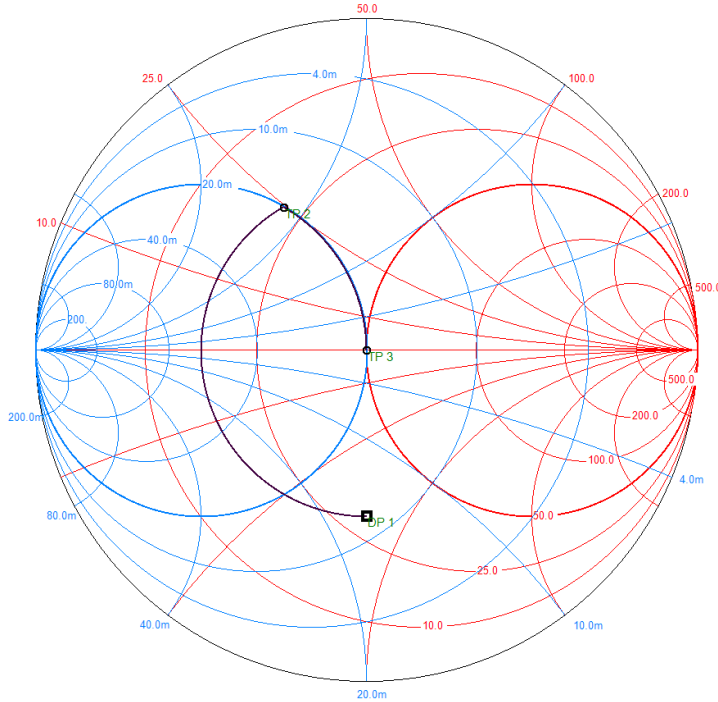

Start DP	Point	Z	Q	Frequency
<input checked="" type="checkbox"/>	DP 1	$(30.000 - j40.000) \Omega$	Q=1.333	430.000MHz
	TP 2	$(21.398 + j24.666) \Omega$	Q=1.153	430.000MHz
	TP 3	$(49.830 - j0.146) \Omega$	Q=0.003	430.000MHz



Example 9: Antenna match using serie line and open stub

Problem: Match an antenna impedance of $(30 - j40)\Omega$ to 50Ω . Use one serie line and an open stub. Frequency: 430 MHz.

Smith project file: Example9.xmlsc

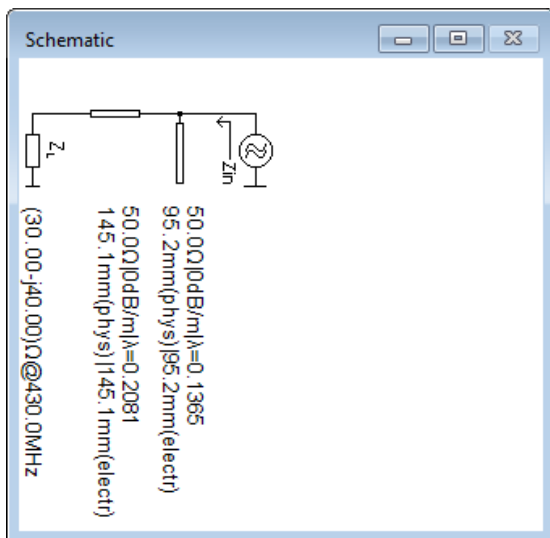
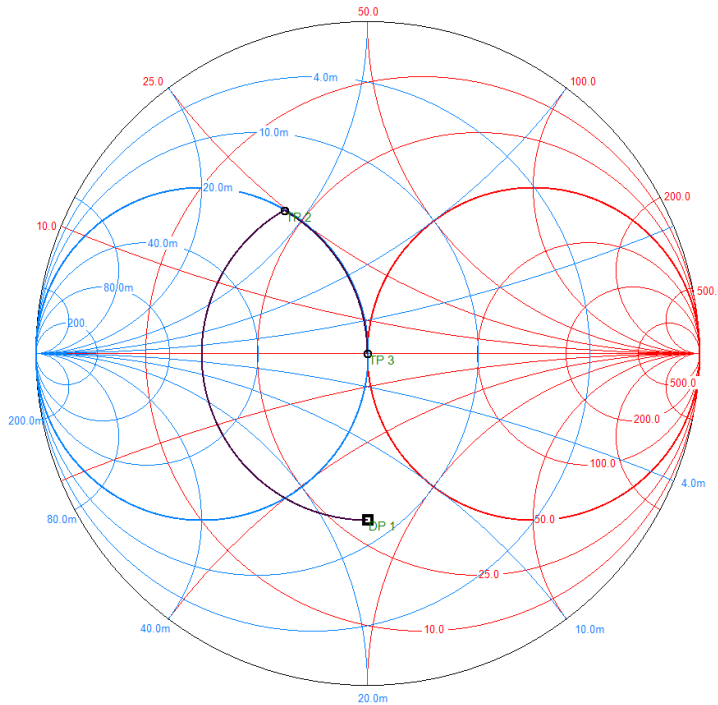

Start DP	Point	Z	Q	Frequency
<input checked="" type="checkbox"/>	DP 1	$(30.000 - j40.000)\Omega$	Q=1.333	430.000MHz
	TP 2	$(21.398 + j24.666)\Omega$	Q=1.153	430.000MHz
	TP 3	$(49.831 - j0.000)\Omega$	Q=0.000	430.000MHz



Example 10: Antenna match using serie line and shorted stub

Problem: Match an antenna impedance of $(30 - j40)\Omega$ to 50Ω . Use one serie line and a shorted stub. Frequency: 430 MHz.

Smith project file: Example10.xmlsc

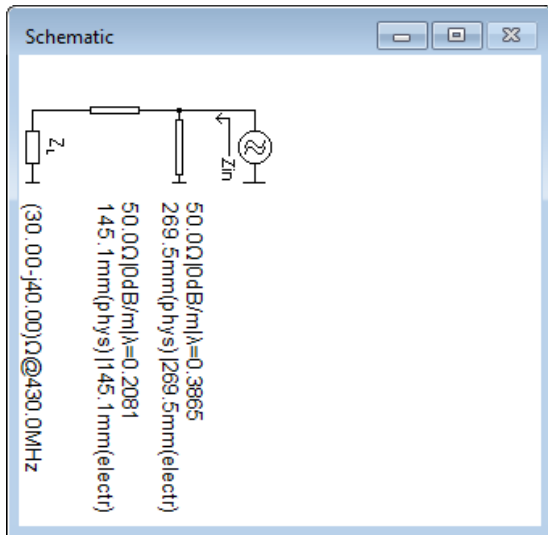
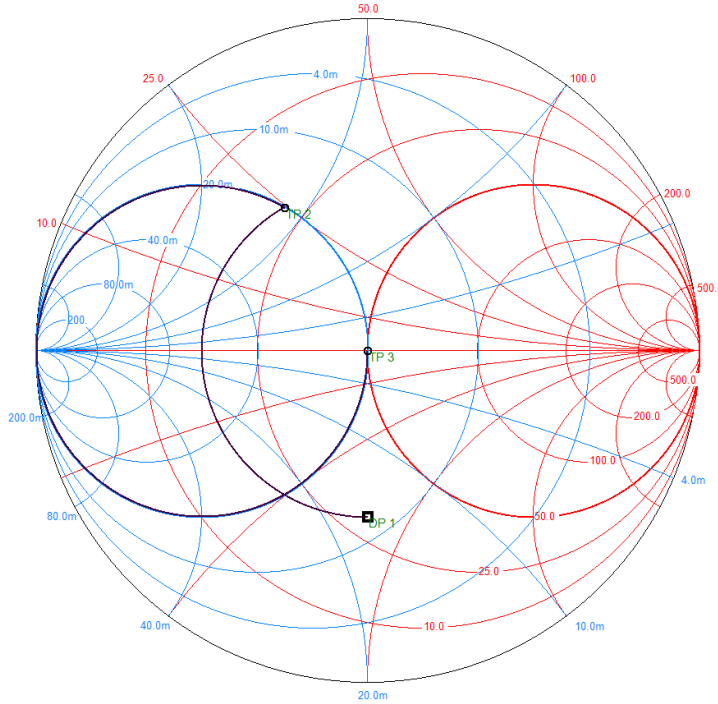

Start DP	Point	Z	Q	Frequency
<input checked="" type="checkbox"/>	DP 1	$(30.000 - j40.000)\Omega$	Q=1.333	430.000MHz
	TP 2	$(21.398 + j24.666)\Omega$	Q=1.153	430.000MHz
	TP 3	$(49.831 + j0.029)\Omega$	Q=0.001	430.000MHz



Example 11: Antenna match using double stub tuner

Problem: Match an antenna impedance of $(30 - j40)\Omega$ to 50Ω . Use a double stub tuner with serie line length of 80 mm with $\epsilon_r = 1$ and Frequency: 430 MHz.

Smith project file: Example11.xmlsc

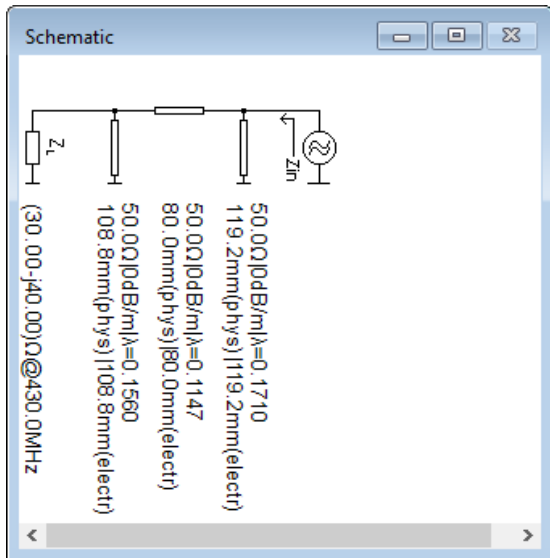
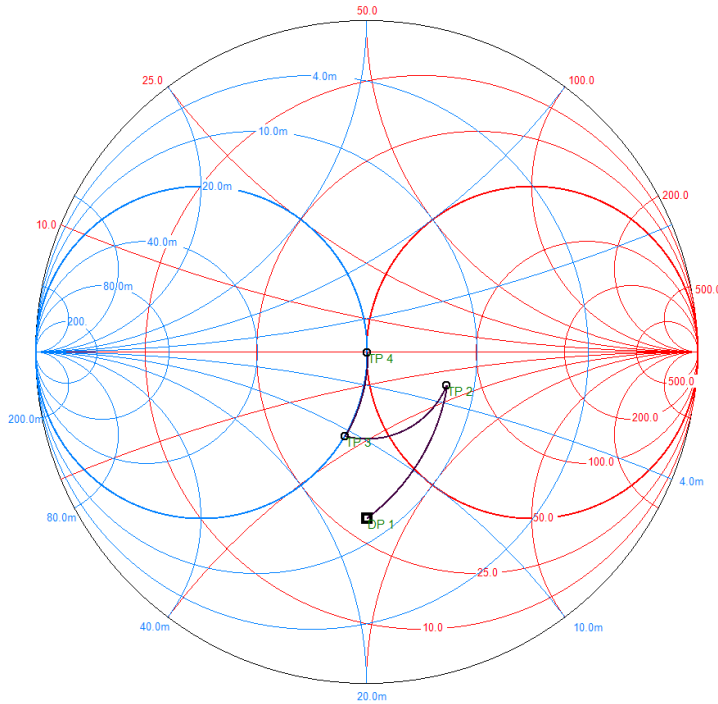

Start DP	Point	Z	Q	Frequency
<input checked="" type="checkbox"/>	DP 1	(30.000 - j40.000) Ω	Q=1.333	430.000MHz
	TP 2	(79.622 - j17.191) Ω	Q=0.216	430.000MHz
	TP 3	(38.628 - j20.970) Ω	Q=0.543	430.000MHz
	TP 4	(50.012 - j0.057) Ω	Q=0.001	430.000MHz



Use Edit Element (doubleclick on element in schematic) to adjust for desired line length.

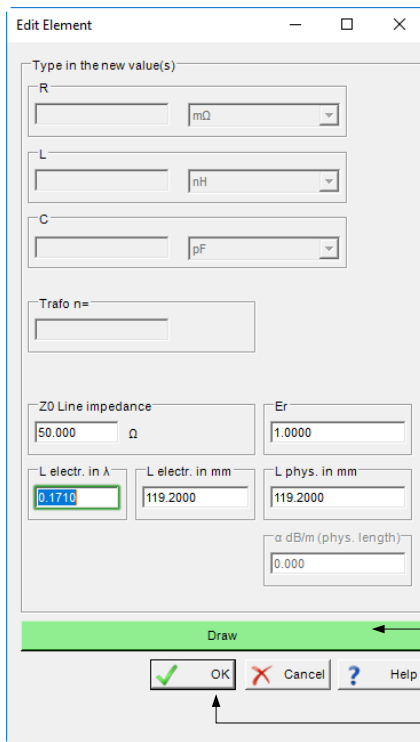

← Change value

Click Draw and see on Smith-chart and schematic how this affect transformation

OK when done

Or use tuning cockpit (Tune) to adjust for desired line length.

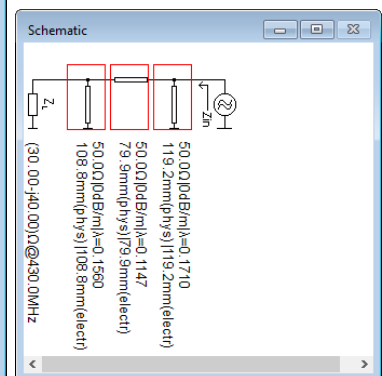
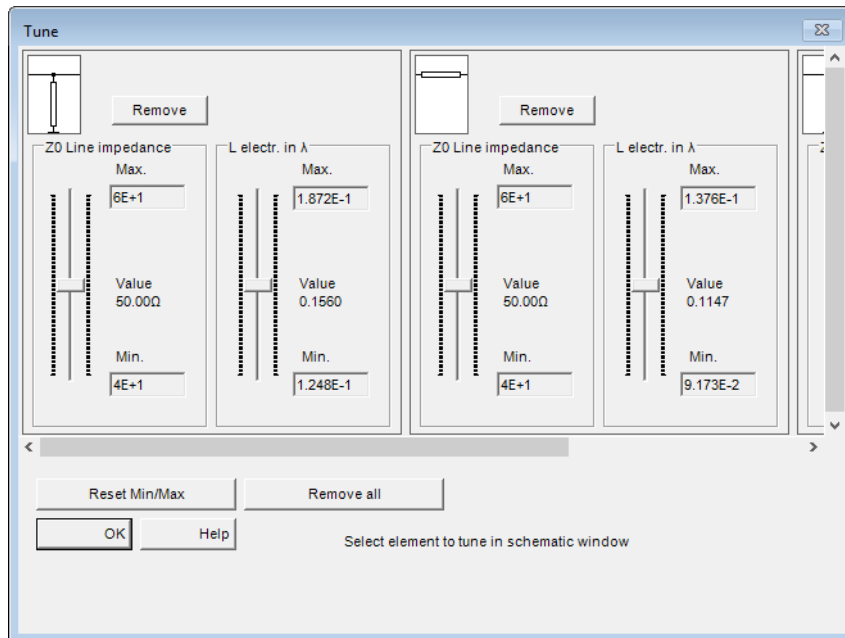



Example 12: Nonsynchronous Transformer

Problem: Match an impedance of $(10 + j12)\Omega$ to 50Ω . Use an open stub and a nonsynchronous transformer. Frequency: 2.4 GHz.

Smith project file: Example12.xmlsc

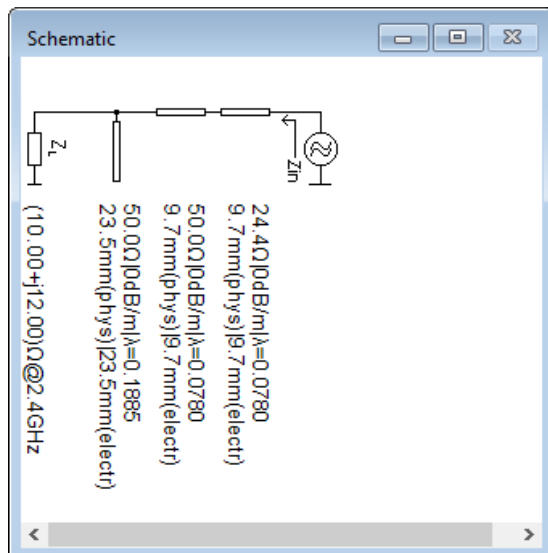
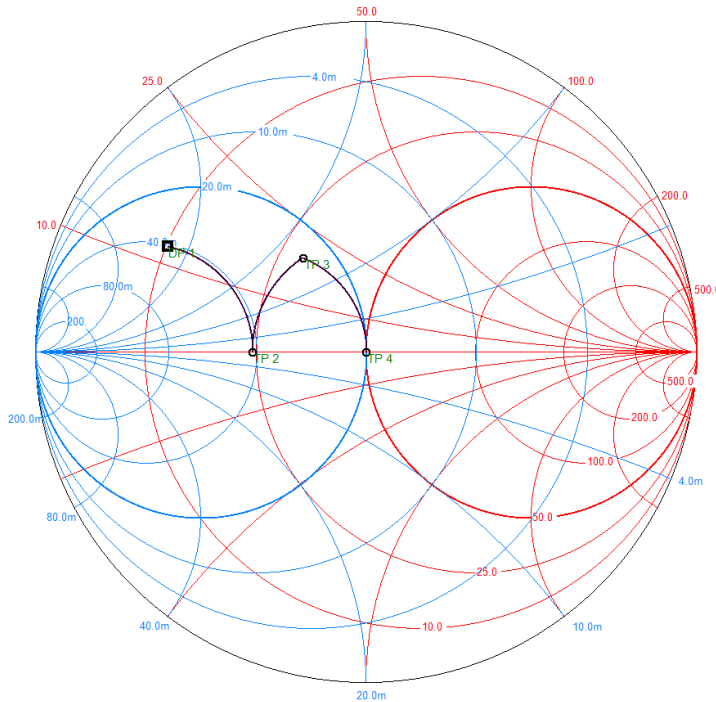

Datapoints

Start DP	Point	Z	Q	Frequency
<input checked="" type="checkbox"/>	DP 1	$(10.000 + j12.000)\Omega$	$Q=1.200$	2.400GHz
	TP 2	$(24.400 + j0.000)\Omega$	$Q=0.000$	2.400GHz
	TP 3	$(29.355 + j19.033)\Omega$	$Q=0.648$	2.400GHz
	TP 4	$(50.090 - j0.171)\Omega$	$Q=0.003$	2.400GHz



Use Edit Element (doubleclick on element in schematic) to adjust for desired line length.

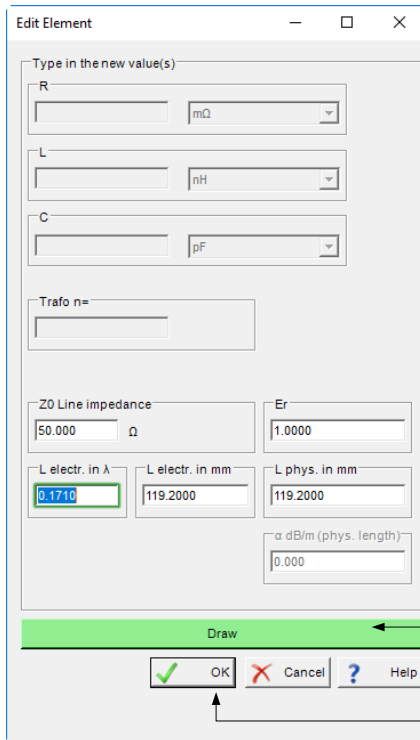

← Change value

Click Draw and see on Smith-chart and schematic how this affect transformation

OK when done

Or use tuning cockpit (Tune) to adjust for desired line length.

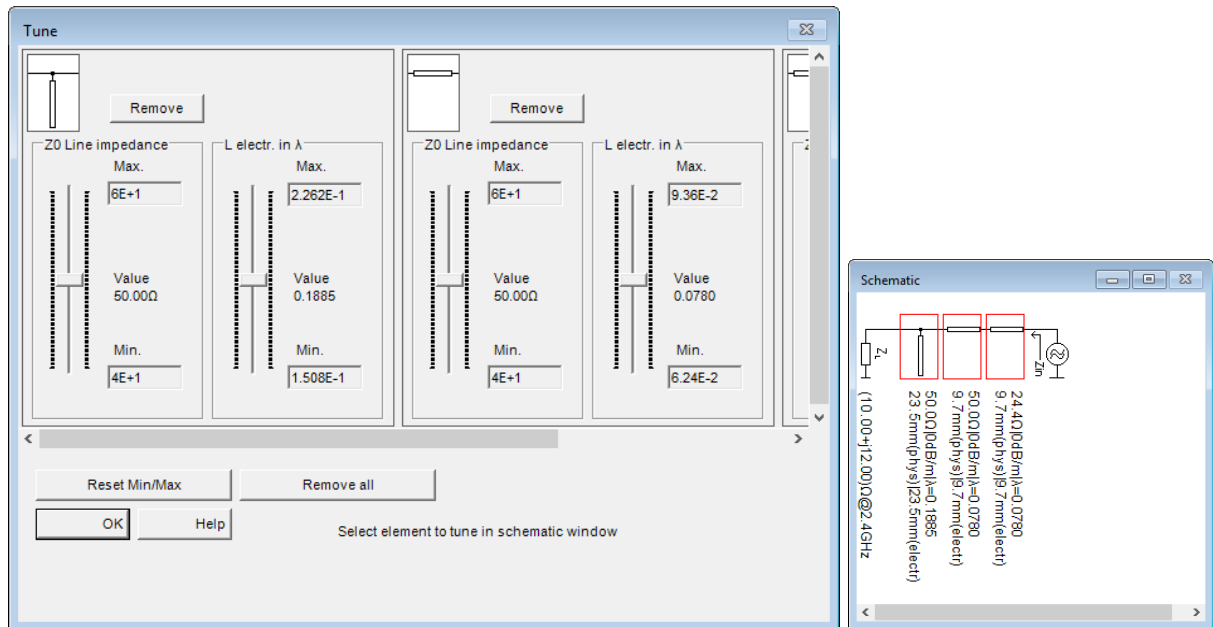



Properties of Nonsynchronous Trafo:

It uses two pieces of line with the same length. One line must have the line impedance of the source and the other line the impedance of the load. The total length depends on impedance ratio and is much shorter than $\lambda / 4$.

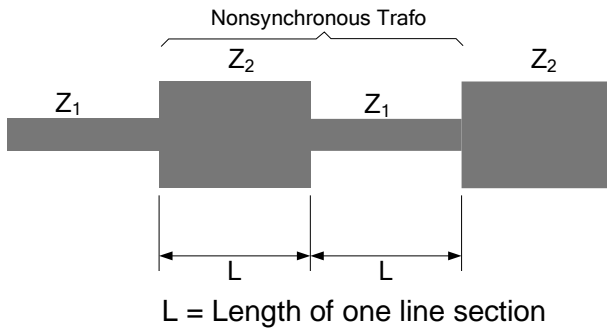

$$k = Z_1 / Z_2 \quad L = \frac{\lambda}{2\pi\sqrt{\epsilon_r}} \arctan \left(\frac{1}{\sqrt{k + \frac{1}{k} + 1}} \right)$$

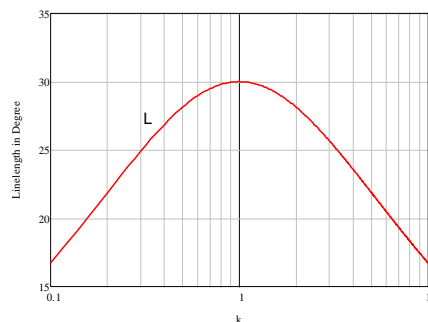
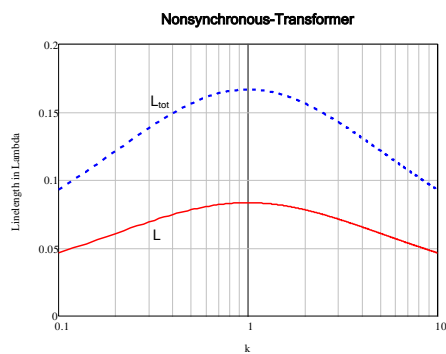

Line length as function of impedance ratio k



Low Noise Amplifier Design

Example 13: Low Noise Amplifier, 2.0 GHz

Problem: Design input and output matching network for a LNA using BFG33G.
 Frequency: 2 GHz

Smith project file: Example13-input.xmlsc

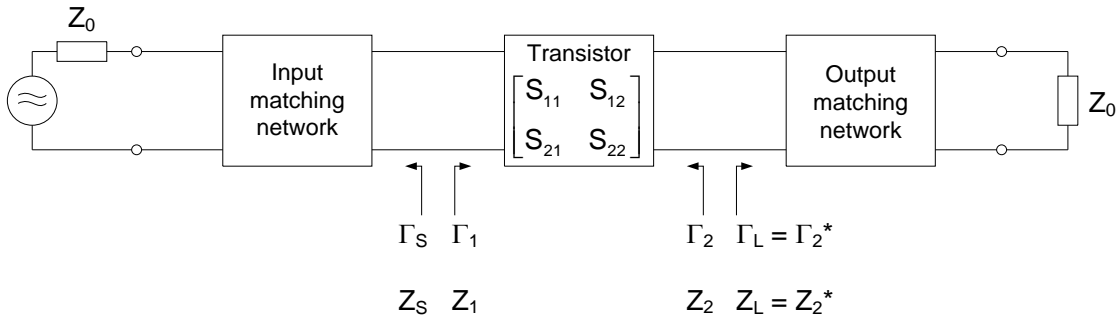

Import S-Parameters for device BFG33G at 2.0 GHz.

The screenshot shows the 'Circles' software interface. The 'Import' tab is selected, and 'S-Parameter' is highlighted. A 'Select File' dialog box is open, showing a file browser with 'af541432b.s2p' selected. Below, the 'S-Parameters' table is visible with the 2000000 Hz row highlighted.

Frequency [Hz]	S11 Mag	S11 Angle	S21 Mag	S21 Angle	S12 Mag	S12 Angle	S22 Mag	S22 Angle
40 000	0.828	-4.800	13.346	173.100	0.005	83.900	0.964	-4.600
100 000	0.813	-11.900	12.873	164.500	0.012	79.300	0.941	-11.500
200 000	0.752	-23.500	12.216	151.500	0.022	72.000	0.887	-21.300
300 000	0.677	-34.700	11.599	141.100	0.031	67.200	0.794	-28.400
400 000	0.596	-45.000	10.955	132.100	0.037	63.800	0.714	-33.900
500 000	0.524	-55.200	10.150	124.000	0.043	61.800	0.654	-37.700
600 000	0.449	-65.100	9.558	118.100	0.048	61.100	0.605	-40.400
700 000	0.387	-73.000	8.832	112.400	0.053	60.500	0.568	-42.200
800 000	0.338	-79.800	8.108	107.600	0.057	60.400	0.539	-43.500
900 000	0.297	-85.300	7.408	103.700	0.062	60.300	0.516	-44.500
1000 000	0.264	-91.300	6.812	100.300	0.066	60.300	0.498	-45.500
1200 000	0.211	-104.400	5.875	94.500	0.074	60.200	0.463	-47.500
1400 000	0.164	-118.200	5.207	89.700	0.083	60.000	0.441	-49.700
1600 000	0.128	-132.000	4.620	85.500	0.092	59.900	0.430	-52.000
1800 000	0.108	-145.900	4.151	82.400	0.100	59.900	0.422	-53.400
2000 000	0.121	-149.000	3.756	78.900	0.109	59.400	0.410	-54.500
2200 000	0.140	-149.800	3.454	75.800	0.116	58.700	0.394	-55.800
2400 000	0.130	-179.800	3.192	72.200	0.123	57.800	0.373	-60.100
2600 000	0.143	168.900	2.956	69.700	0.131	57.100	0.368	-64.900



Draw circles for gain:

Circles

Gain | VSWR | Stability | NoiseFigure

Select gain
 Available Power Gain Operating Power Gain

Unilateral
 Source Load

Frequency: 2000MHz

S11: Magnitude 0.121, Angle [-] -149.000
 Polar Cartesian dB

S12: Magnitude 0.108, Angle [-] 59.400
 Polar Cartesian dB

S21: Magnitude 3.756, Angle [-] 78.900
 Polar Cartesian dB

S22: Magnitude 0.410, Angle [-] -54.500
 Polar Cartesian dB

Import: S-Parameter

Gain to show: K 1.166, Power gain [dB] 12.942, Gmax [dB] 12.943

Draw

OK Cancel Help

Specify Power gain of 12.94 dB
12.50 dB
12.00 dB

and draw each circle

Draw stability circles:

Circles

Gain | VSWR | Stability | NoiseFigure

Select Plane
 Input Output

Import: S-Parameter

Frequency: 2000MHz

S11: Magnitude 0.121, Angle [-] -149.000
 Polar Cartesian dB

S12: Magnitude 0.108, Angle [-] 59.400
 Polar Cartesian dB

S21: Magnitude 3.756, Angle [-] 78.900
 Polar Cartesian dB

S22: Magnitude 0.410, Angle [-] -54.500
 Polar Cartesian dB

Draw

OK Cancel Help

Stability circle for Input and Output Plane



Draw Noise figure circles:

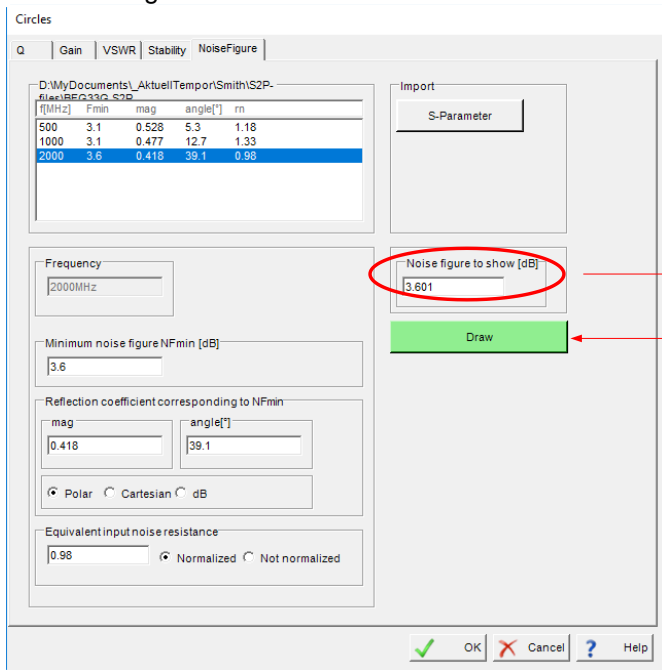

Specify Noise figure of
 3.601 dB
 3.7 dB
 3.8 dB
 3.9 dB
 4.0 dB
 and draw each circle

Input matching network:

If we choose a source impedance of $Z_S = (50+j30)\Omega$ we get a gain of approx. 12 dB and a NF of approx. 3.85 dB with only a serie inductor as input matching network.

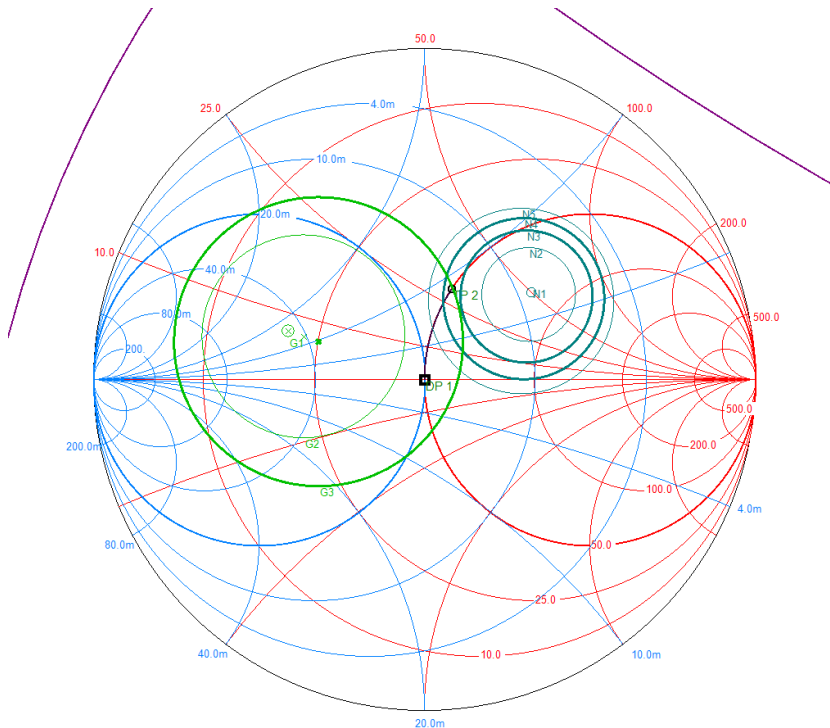

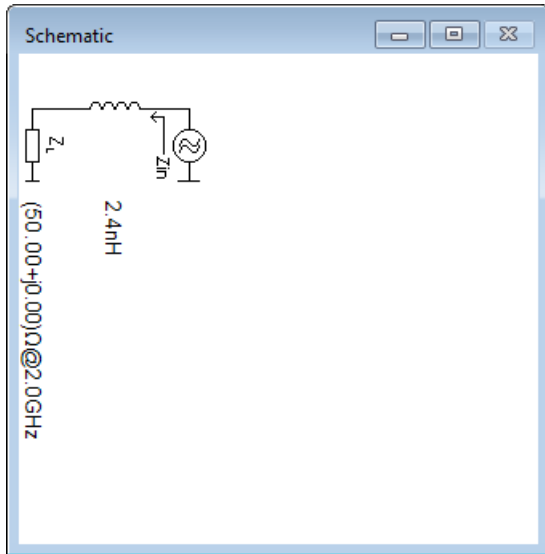

Start DP	Point	Z	Q	Frequency
<input checked="" type="checkbox"/>	DP 1	(50.000 + j0.000) Ω	Q=0.000	2.000GHz
	TP 2	(50.000 + j30.034) Ω	Q=0.601	2.000GHz

Visible	Highlighted	Details
<input checked="" type="checkbox"/>	<input type="checkbox"/>	G1: input plane const. gain circle ;Vp=12.94dB ;Gmax=12.94dB ;S11=0.12 < -149.00°; S12=0.11 < 59.40°; S21=3.76 < 78.90°; S22=0.41 < -54.50°; 2.0GHz
<input checked="" type="checkbox"/>	<input type="checkbox"/>	G2: input plane const. gain circle ;Vp=12.50dB ;Gmax=12.94dB ;S11=0.12 < -149.00°; S12=0.11 < 59.40°; S21=3.76 < 78.90°; S22=0.41 < -54.50°; 2.0GHz
<input checked="" type="checkbox"/>	<input checked="" type="checkbox"/>	G3: input plane const. gain circle ;Vp=12.00dB ;Gmax=12.94dB ;S11=0.12 < -149.00°; S12=0.11 < 59.40°; S21=3.76 < 78.90°; S22=0.41 < -54.50°; 2.0GHz
<input checked="" type="checkbox"/>	<input type="checkbox"/>	S1: Input plane stability circle; stable inside; K=1.17; S11=0.12 < -149.00°; S12=0.11 < 59.40°; S21=3.76 < 78.90°; S22=0.41 < -54.50°; 2.0GHz
<input checked="" type="checkbox"/>	<input type="checkbox"/>	S2: Output plane stability circle; stable outside; K=1.17; S11=0.12 < -149.00°; S12=0.11 < 59.40°; S21=3.76 < 78.90°; S22=0.41 < -54.50°; 2.0GHz
<input checked="" type="checkbox"/>	<input type="checkbox"/>	N1: Constant 3.60dB noise figure circle; NFmin = 3.60dB; Γ_NFmin = 0.42 < 39.10; rnoise = 0.98;2.0GHz
<input checked="" type="checkbox"/>	<input type="checkbox"/>	N2: Constant 3.70dB noise figure circle; NFmin = 3.60dB; Γ_NFmin = 0.42 < 39.10; rnoise = 0.98;2.0GHz
<input checked="" type="checkbox"/>	<input checked="" type="checkbox"/>	N3: Constant 3.80dB noise figure circle; NFmin = 3.60dB; Γ_NFmin = 0.42 < 39.10; rnoise = 0.98;2.0GHz
<input checked="" type="checkbox"/>	<input checked="" type="checkbox"/>	N4: Constant 3.90dB noise figure circle; NFmin = 3.60dB; Γ_NFmin = 0.42 < 39.10; rnoise = 0.98;2.0GHz
<input checked="" type="checkbox"/>	<input type="checkbox"/>	N5: Constant 4.00dB noise figure circle; NFmin = 3.60dB; Γ_NFmin = 0.42 < 39.10; rnoise = 0.98;2.0GHz

With a few calculations we get:

S-parameters at 2000 MHz:

$$S_{mn} := \begin{pmatrix} 0.121 \cdot e^{j \cdot -149 \cdot \text{deg}} & 0.108 \cdot e^{j \cdot 59.4 \cdot \text{deg}} \\ 3.756 \cdot e^{j \cdot 78.9 \cdot \text{deg}} & 0.41 \cdot e^{j \cdot -54.5 \cdot \text{deg}} \end{pmatrix}$$

Source impedance at 2000 MHz

$$Z_S := (50 + j \cdot 30) \cdot \Omega$$

$$Z_0 := 50 \cdot \Omega$$

$$\Gamma_S := \frac{Z_S - Z_0}{Z_S + Z_0} = 0.083 + 0.275j$$

$$|\Gamma_S| = 0.287$$

$$\arg(\Gamma_S) = 73.301 \text{ deg}$$

$$\Gamma_2 := S_{2,2} + \frac{S_{1,2} \cdot S_{2,1} \cdot \Gamma_S}{1 - S_{1,1} \cdot \Gamma_S} = 0.136 - 0.392j$$

$$Z_2 := Z_0 \cdot \frac{1 + \Gamma_2}{1 - \Gamma_2} = (45.987 - 43.54j) \Omega$$

For the output network we conjugately match Z_2 (or Γ_2) to 50 Ohm.

There are several possibilities to realize the output matching network.



Problem: Output matching network 1
Smith project file: Example13-output1.xmlsc

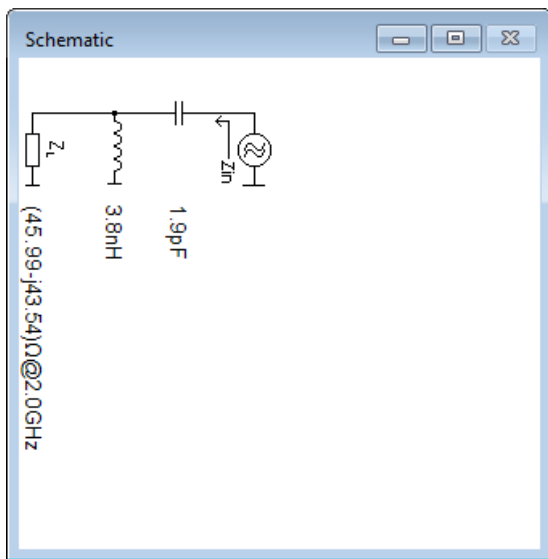
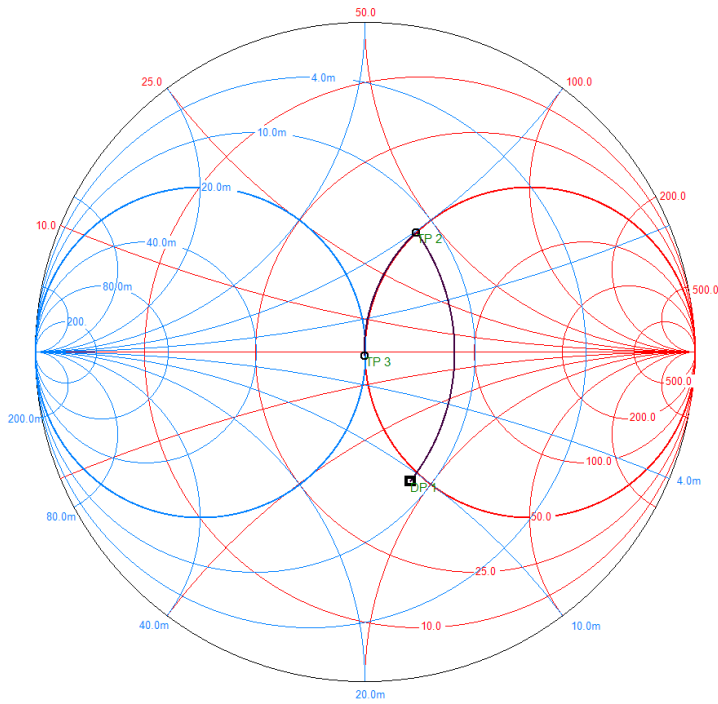

Datapoints

Start DP	Point	Z	Q	Frequency
<input checked="" type="checkbox"/>	DP 1	$(45.990 - j43.540) \Omega$	$Q=0.947$	2.000GHz
	TP 2	$(49.638 + j43.186) \Omega$	$Q=0.870$	2.000GHz
	TP 3	$(49.638 + j1.303) \Omega$	$Q=0.026$	2.000GHz

Simulation of LNA with Output matching network 1 versus Frequency in Agilent ADS:

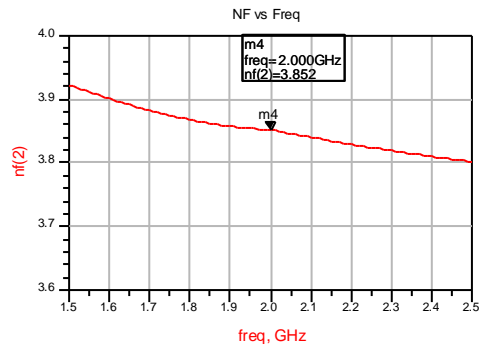
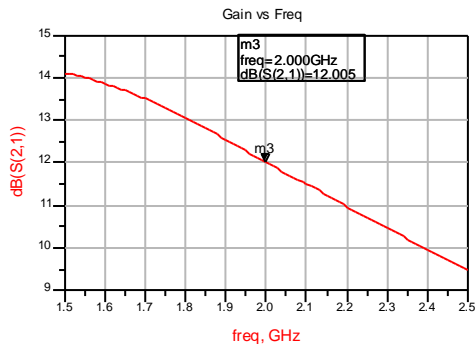
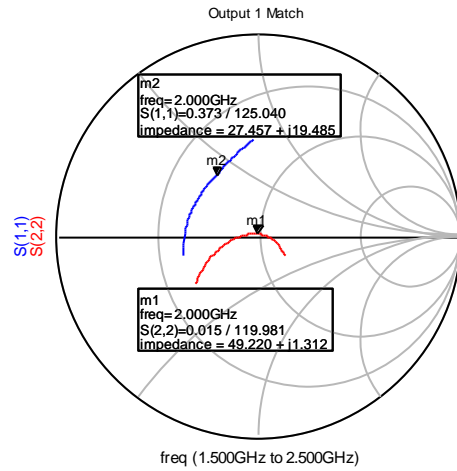
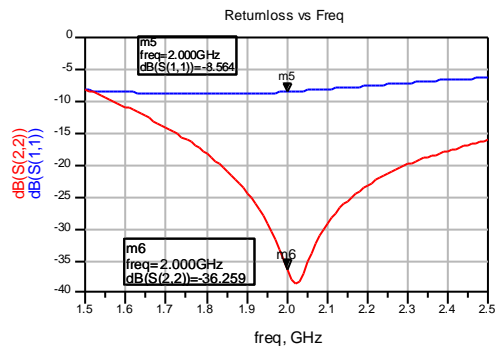
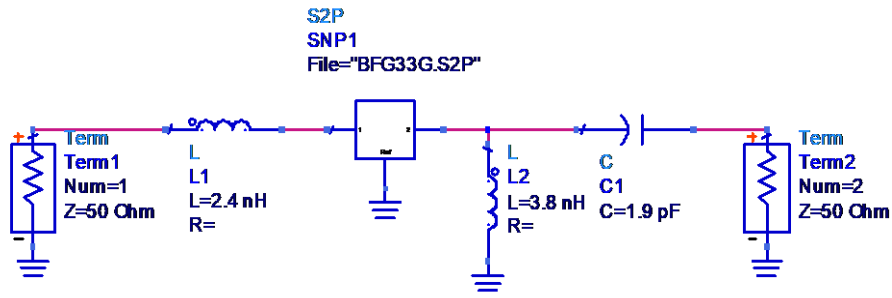



Problem: Output matching network 2
 Smith project file: Example13-output2.xmlsc

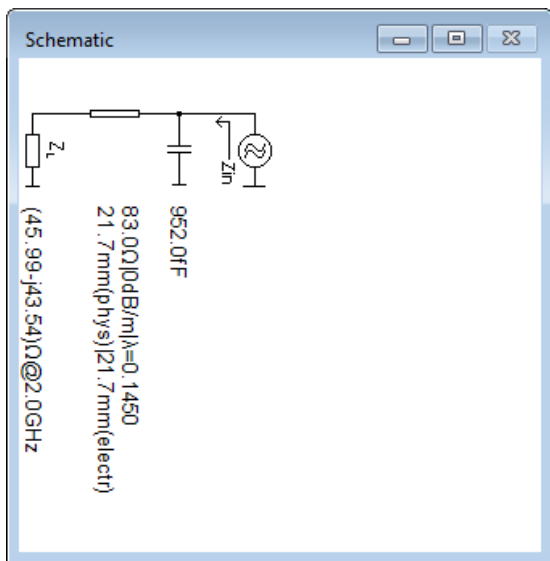
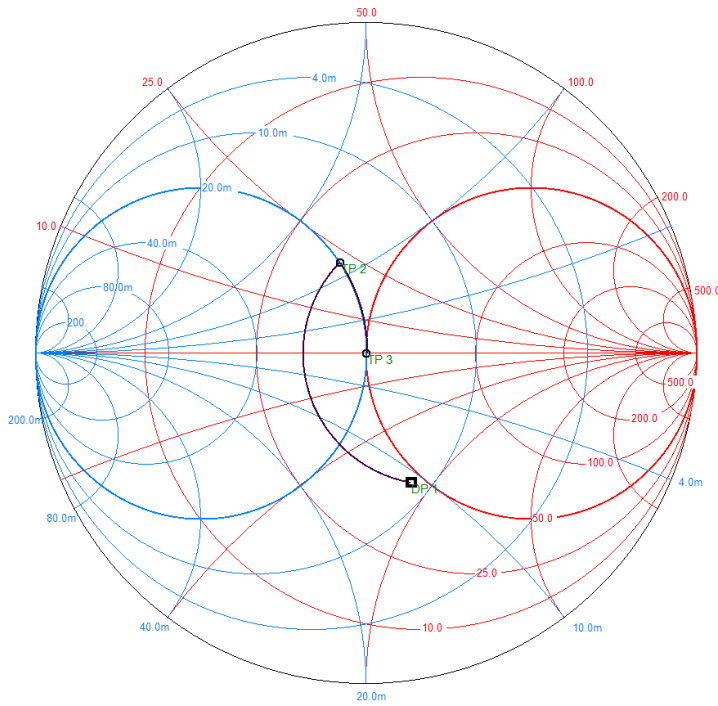

Datapoints

Start DP	Point	Z	Q	Frequency
<input checked="" type="checkbox"/>	DP 1	$(45.990 - j43.540) \Omega$	Q=0.947	2.000GHz
	TP 2	$(36.873 + j22.146) \Omega$	Q=0.601	2.000GHz
	TP 3	$(50.174 + j0.018) \Omega$	Q=0.000	2.000GHz



Simulation of LNA with Output matching network 2 versus Frequency in Agilent ADS:

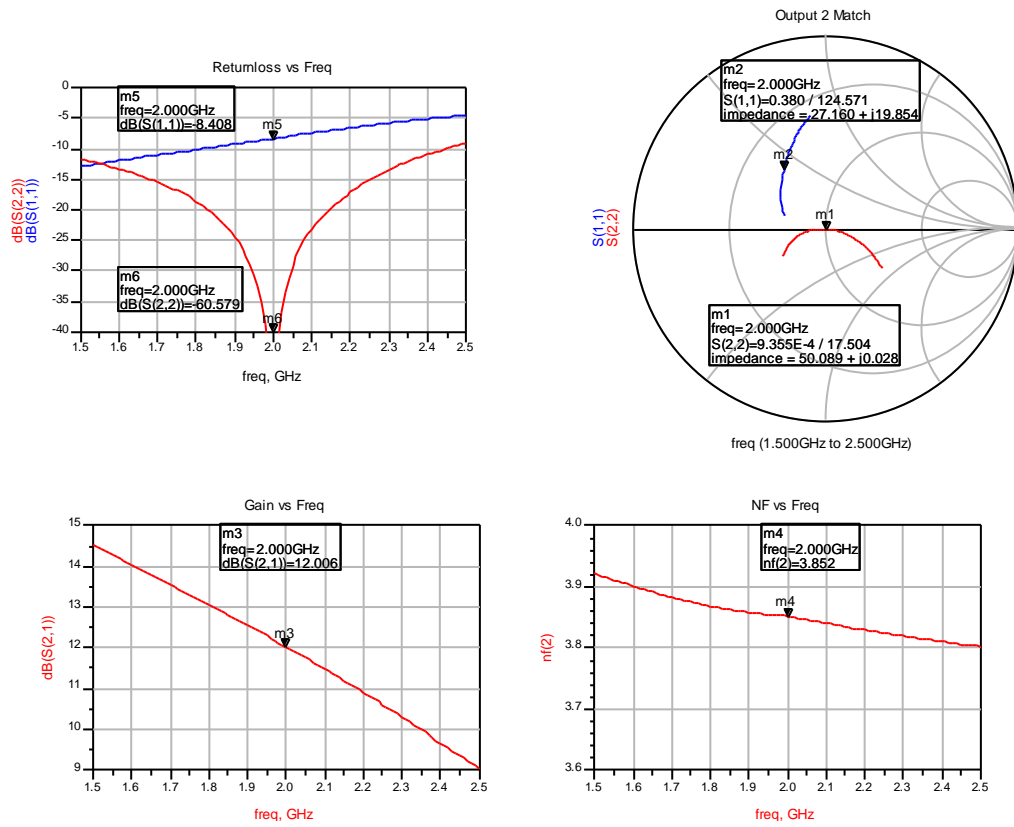



Problem: Output matching network 3
 Smith project file: Example13-output3.xmlsc

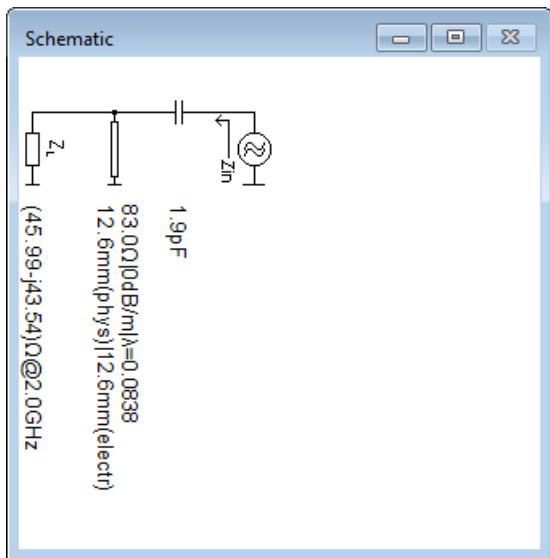
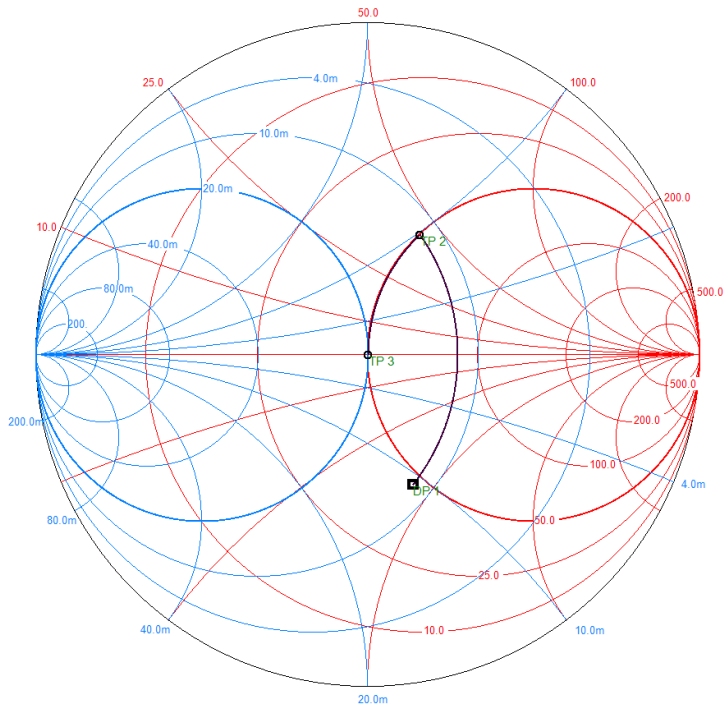

Datapoints

Start DP	Point	Z	Q	Frequency
<input checked="" type="checkbox"/>	DP 1	$(45.990 - j43.540) \Omega$	Q=0.947	2.000GHz
	TP 2	$(50.087 + j43.121) \Omega$	Q=0.861	2.000GHz
	TP 3	$(50.087 + j0.106) \Omega$	Q=0.002	2.000GHz



Simulation of LNA with Output matching network 3 versus Frequency in Agilent ADS:

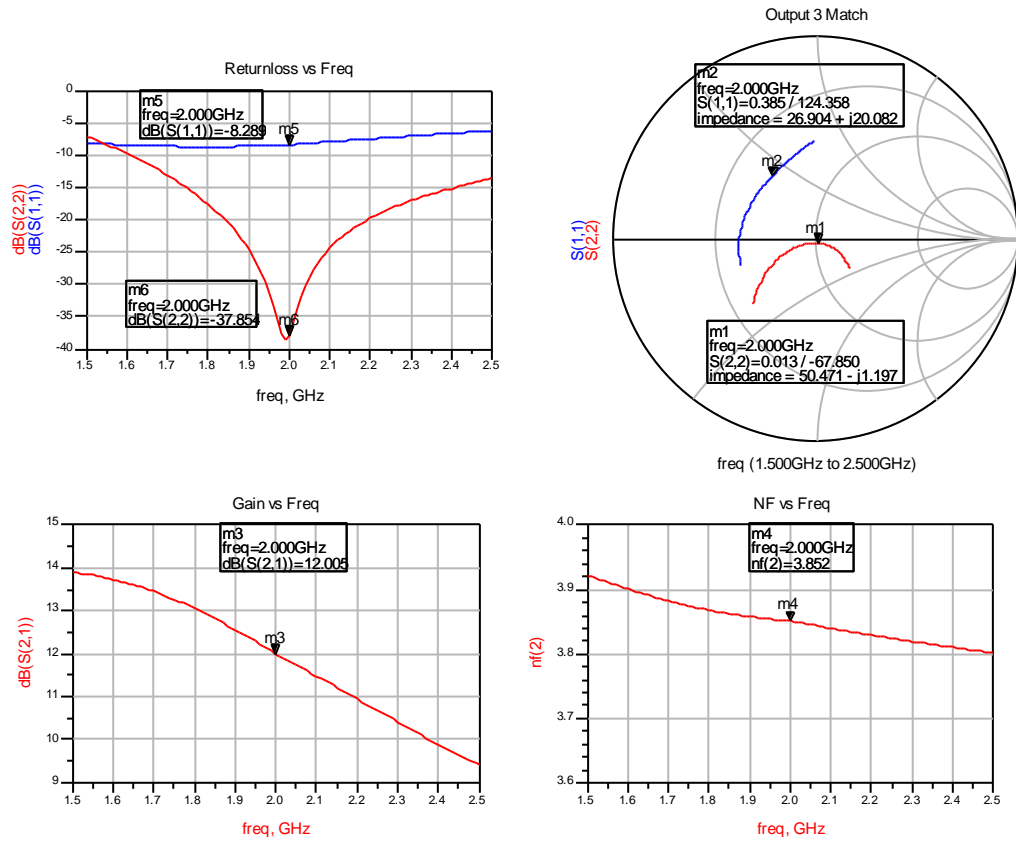



Conjugate Matching

Example 14: Conjugate Match

Problem: Conjugately match impedance Z_1 (or Gamma Γ_1) to 50 Ohm.

Method 1: Start at Z_1 and transform with network to 50 Ohm.

In this case Z_1 is used as load impedance for the network and after transformation we would like to see 50 Ohm at the input of the network.

Method 2: Start at 50 Ohm and transform with network to $Z_1^* = \text{conjugate } Z_1$

In this case 50 Ohm is used as load impedance for the network and after transformation we would like to see Z_1^* into the input of the network.

Both method result in the same network.

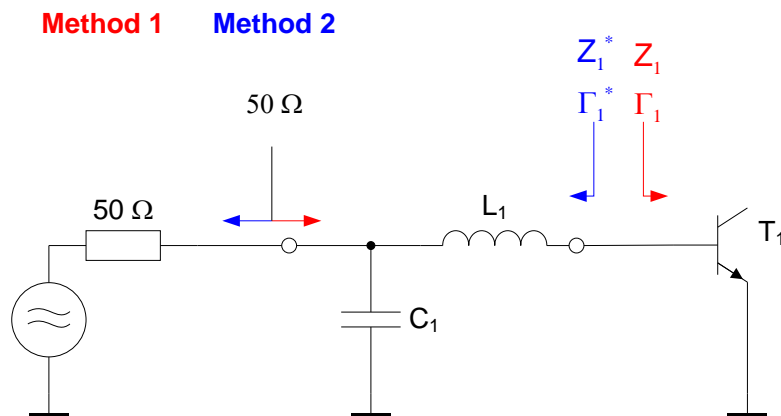



Example: $Z_1 = (10 - j10)\Omega$

Method 1:

Smith project file: Example14-1.xmlsc

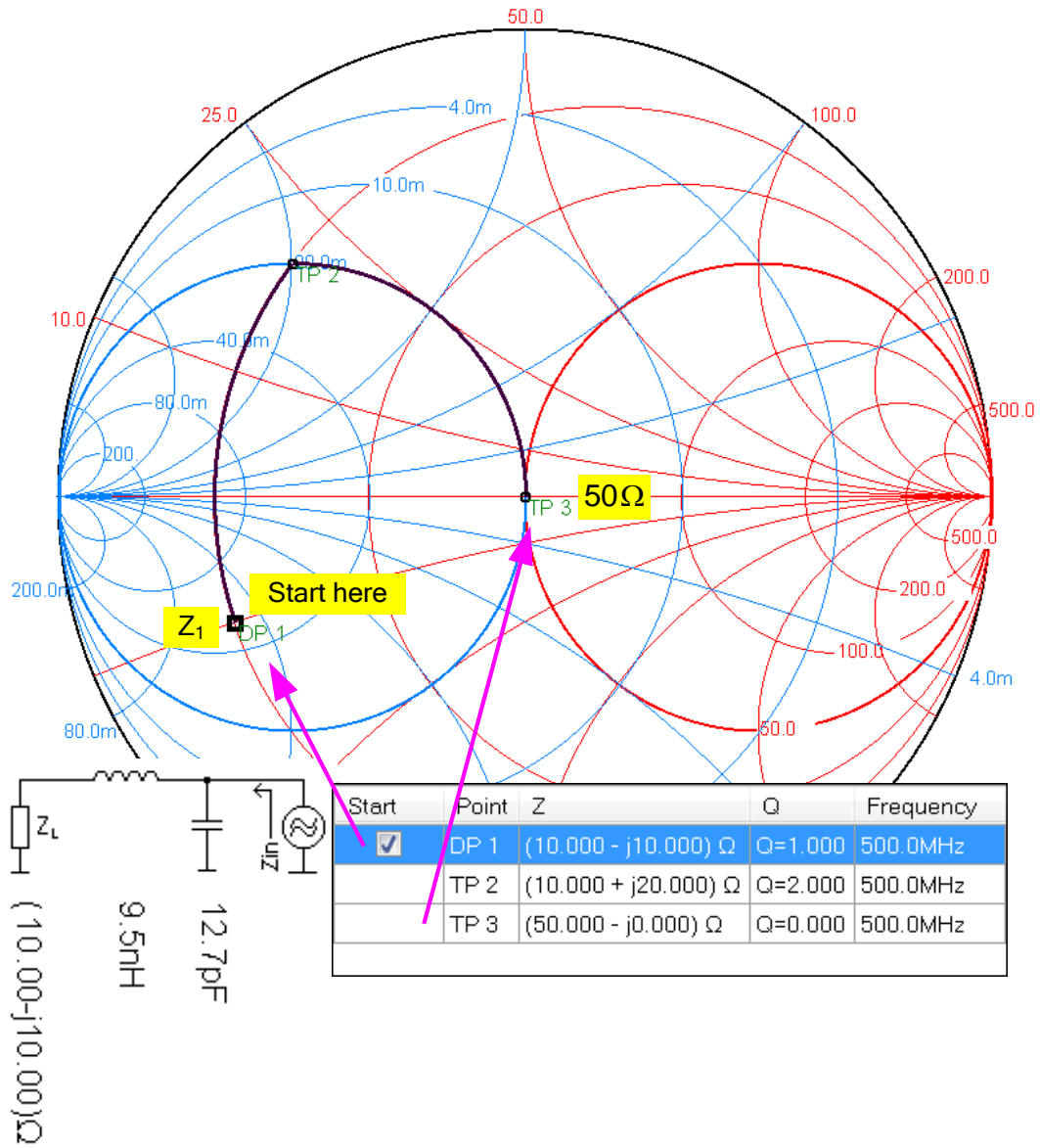



Method 2:
Smith project file: Example14-2.xmlsc

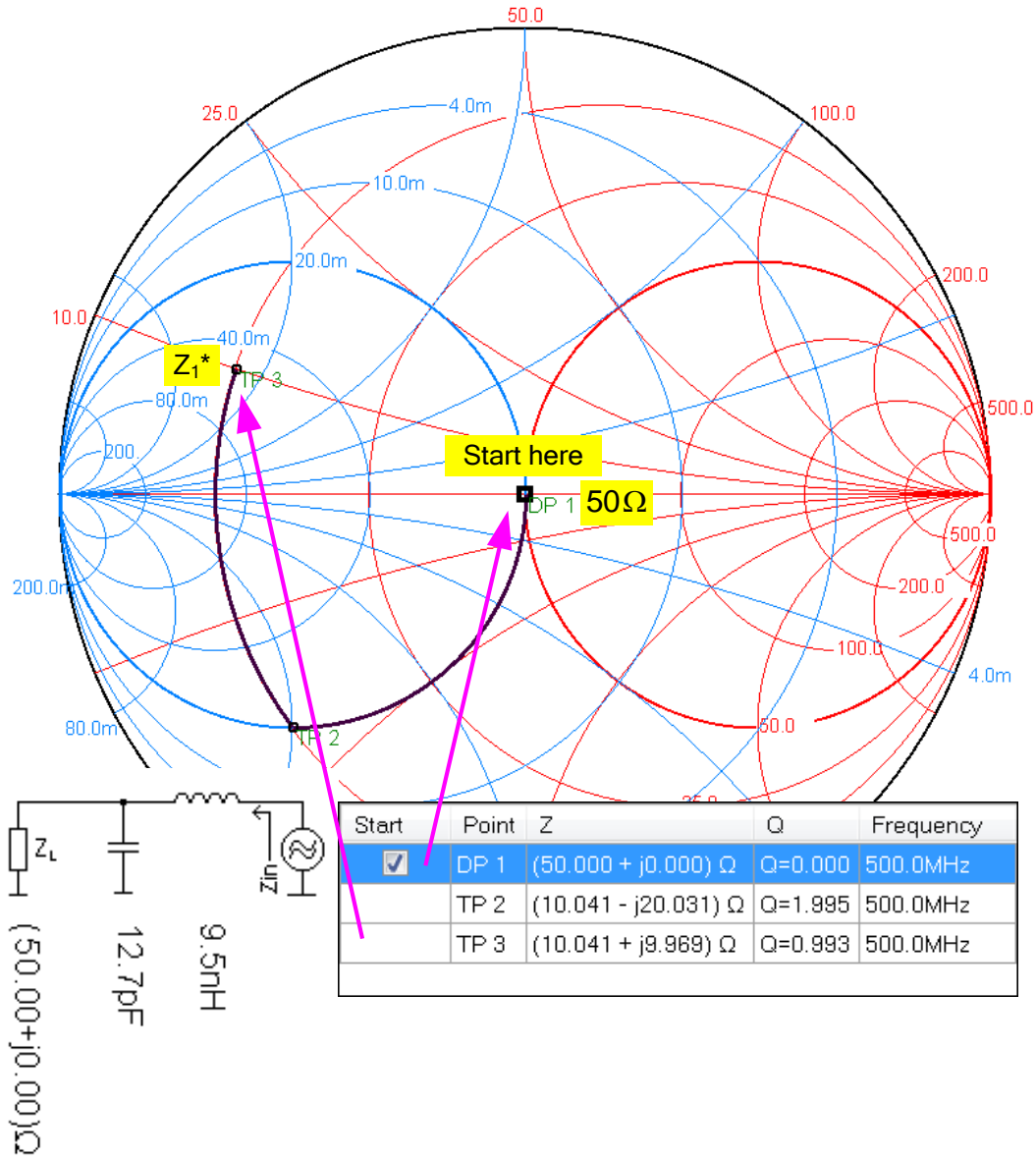



Serial Transmission Line with Attenuation

Example 15: Match using transmission line with loss

Problem: Match an impedance of $(23.7 + j 101)$ Ohm to 50 Ohm using a lossy transmission line with an electrical length of about 2 wavelength, attenuation of 2 dB/m and a serial reactance.
 Frequency: 500 MHz

Smith project file: Example15.xmlsc

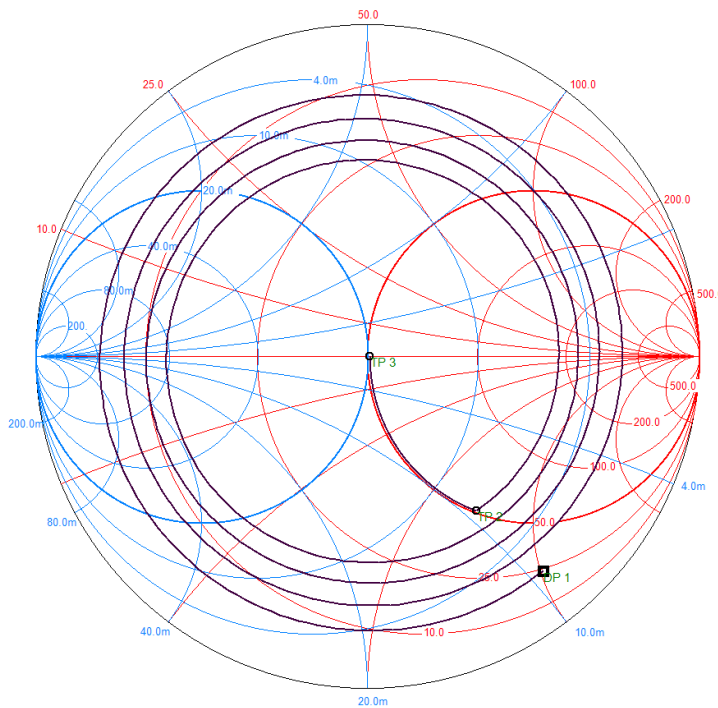

Edit Element

Type in the new value(s)

R: mΩ

L: nH

C: pF

Trafo n=:

Z0 Line impedance: Ω Er:

L electr. in λ: L electr. in m: L phys. in mm:

α dB/m (phys. length):

Draw

OK Cancel Help

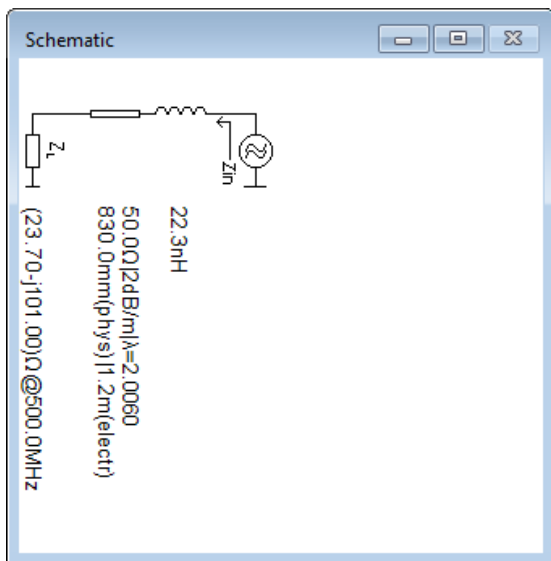

Datapoints

Start DP	Point	Z	Q	Frequency
<input checked="" type="checkbox"/>	DP 1	(23.700 - j101.000) Ω	Q=4.262	500.000MHz
	TP 2	(50.687 - j69.776) Ω	Q=1.377	500.000MHz
	TP 3	(50.687 + j0.281) Ω	Q=0.006	500.000MHz



Sweeps

Example 16: Input impedance of a Chebyshev lowpass filter

Problem: Plot input impedance of a 50 Ohm Chebyshev lowpass filter with $n = 3$, Ripple = 0.1 dB and cut-off frequency = 100 MHz
 Frequency: 10 MHz to 450 MHz

Smith project file: Example16.xmlsc

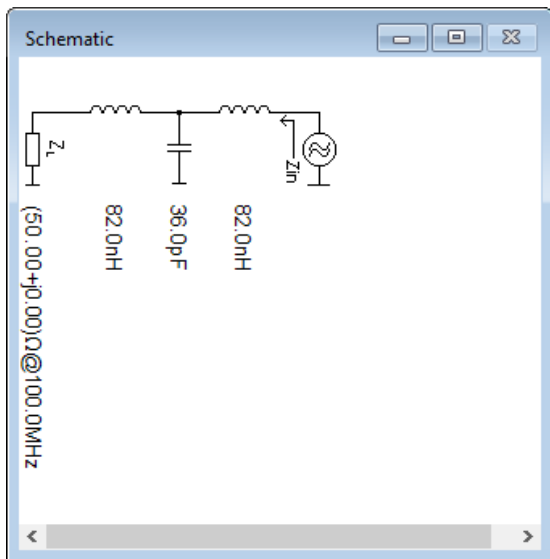
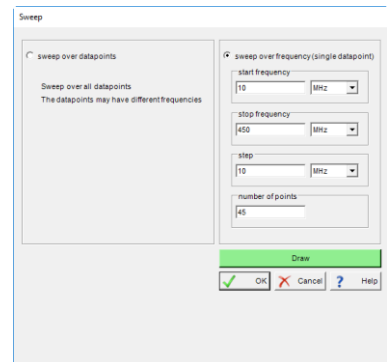
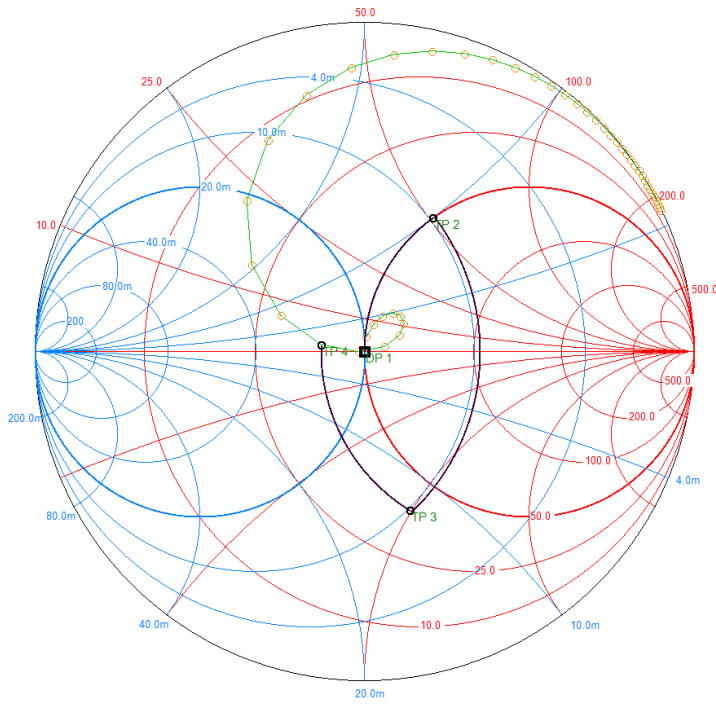

Start DP	Point	Z	Q	Frequency
<input checked="" type="checkbox"/>	DP 1	(50.000 + j0.000) Ω	Q=0.000	100.000MHz
	TP 2	(50.000 + j51.522) Ω	Q=1.030	100.000MHz
	TP 3	(38.271 - j49.807) Ω	Q=1.301	100.000MHz
	TP 4	(38.271 + j1.715) Ω	Q=0.045	100.000MHz
	SP 1	(50.525 + j4.584) Ω	Q=0.091	10.000MHz
	SP 2	(52.078 + j8.757) Ω	Q=0.168	20.000MHz
	SP 3	(54.564 + j12.042) Ω	Q=0.221	30.000MHz
	SP 4	(57.704 + j13.854) Ω	Q=0.240	40.000MHz
	SP 5	(60.830 + j13.572) Ω	Q=0.223	50.000MHz
	SP 6	(62.703 + j10.866) Ω	Q=0.173	60.000MHz
	SP 7	(61.671 + j6.323) Ω	Q=0.103	70.000MHz
	SP 8	(56.612 + j1.857) Ω	Q=0.033	80.000MHz
	SP 9	(48.113 - j0.104) Ω	Q=0.002	90.000MHz
	SP 10	(38.271 + j1.715) Ω	Q=0.045	100.000MHz
	SP 11	(29.139 + j6.877) Ω	Q=0.236	110.000MHz
	SP 12	(21.722 + j14.131) Ω	Q=0.651	120.000MHz
	SP 13	(16.120 + j22.341) Ω	Q=1.386	130.000MHz



Example 17: Broadband load match

Problem: Given: Load impedance = $(100.8+j24.2)$ Ohm @ 140 MHz, $(106.9+j41.7)$ Ohm @ 145 MHz, $(121.2+j60)$ Ohm @ 150 MHz
 Find LC-lowpass network to match within VSWR of 1.2. Use standard component values as possible.
 Frequency: 140 MHz to 150 MHz

Smith project file: Example17.xmlsc

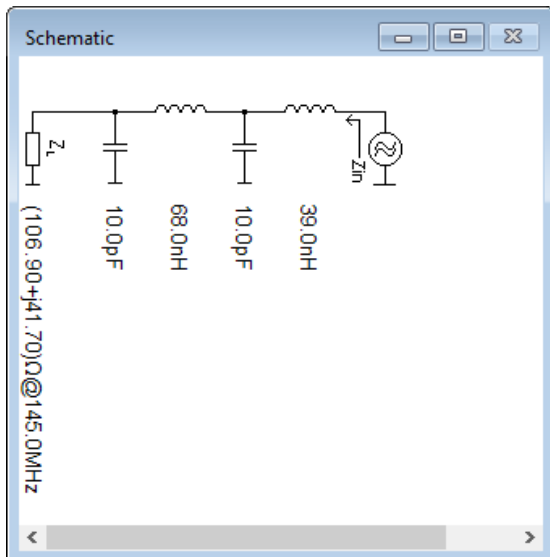
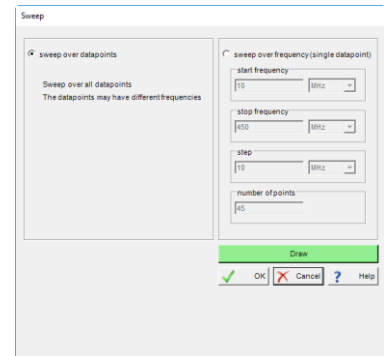
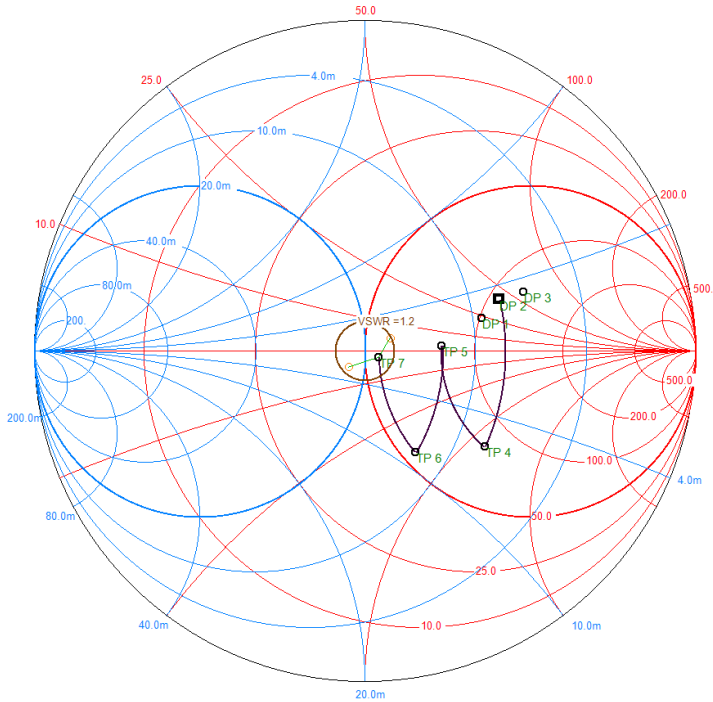

Start DP	Point	Z	Q	Frequency
<input type="checkbox"/>	DP 1	$(100.800 + j24.200) \Omega$	Q=0.240	140.000MHz
<input checked="" type="checkbox"/>	DP 2	$(106.900 + j41.700) \Omega$	Q=0.390	145.000MHz
<input type="checkbox"/>	DP 3	$(121.200 + j60.000) \Omega$	Q=0.495	150.000MHz
	TP 4	$(80.193 - j58.704) \Omega$	Q=0.732	145.000MHz
	TP 5	$(80.193 + j3.248) \Omega$	Q=0.041	145.000MHz
	TP 6	$(54.350 - j37.572) \Omega$	Q=0.691	145.000MHz
	TP 7	$(54.350 - j2.041) \Omega$	Q=0.038	145.000MHz
	SP 1	$(58.151 + j4.882) \Omega$	Q=0.084	140.000MHz
	SP 2	$(54.350 - j2.041) \Omega$	Q=0.038	145.000MHz
	SP 3	$(44.930 - j4.426) \Omega$	Q=0.099	150.000MHz



Tune element values

Example 18: Match an Antenna with Lowpass network and fixed L-values

Problem: Match an antenna impedance of $(61 + j57)\Omega$ to 50Ω . Use L and C in a circuit topology as shown below. Inductors are fixed to a value of 56 nH and capacitors should have a value between 10 and 20 pF. Do not exceed a $Q_{\max} = \frac{X}{R} = \frac{60}{61} \approx 1$.

Frequency: 145 MHz.

Smith project file: Example18.xmlsc

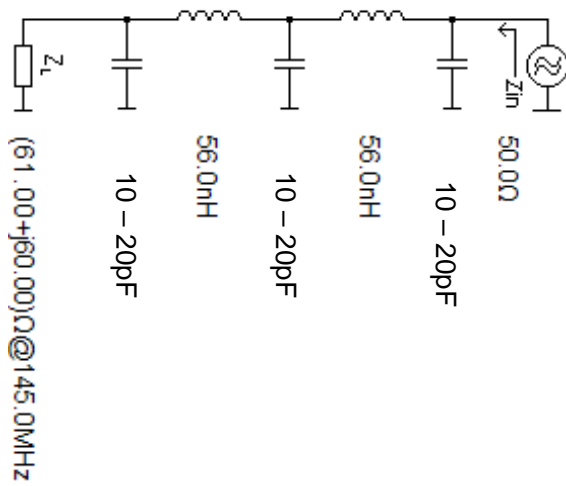



Start with all capacitors 15pF. Tune capacitors to find a solution.

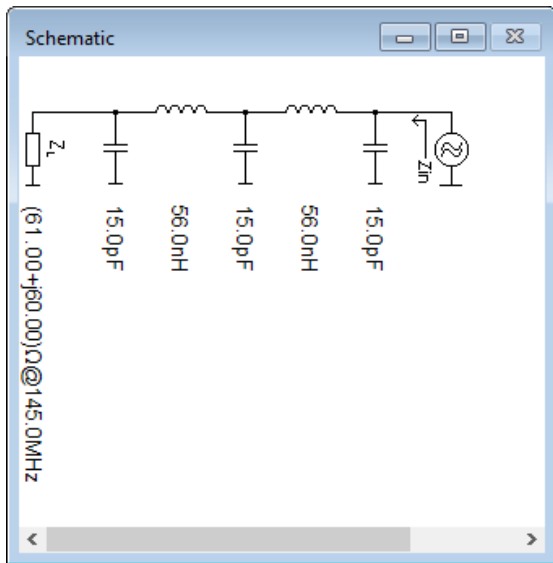
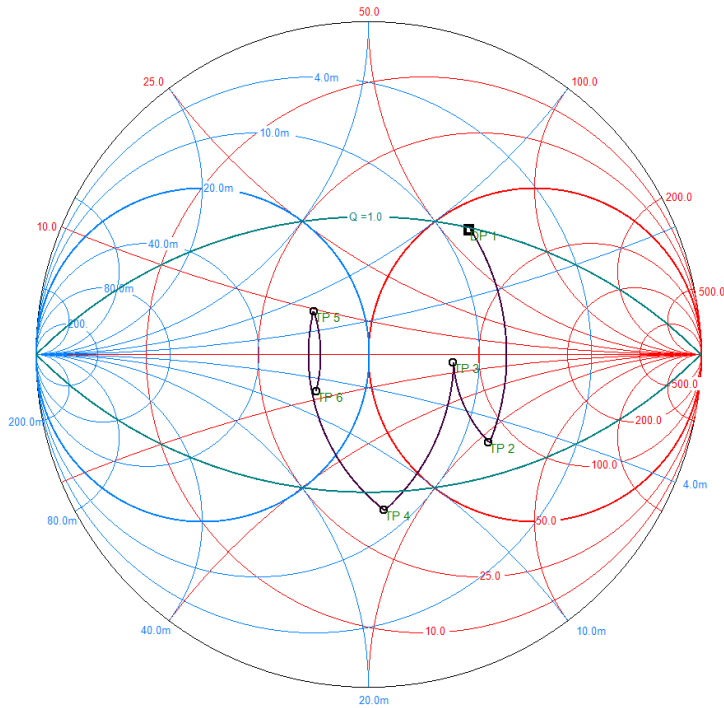

Start DP	Point	Z	Q	Frequency
<input checked="" type="checkbox"/>	DP 1	(61.000 + j60.000) Ω	Q=0.984	145.000MHz
	TP 2	(83.867 - j55.061) Ω	Q=0.657	145.000MHz
	TP 3	(83.867 - j4.042) Ω	Q=0.048	145.000MHz
	TP 4	(34.554 - j41.361) Ω	Q=1.197	145.000MHz
	TP 5	(34.554 + j9.659) Ω	Q=0.280	145.000MHz
	TP 6	(35.389 - j8.125) Ω	Q=0.230	145.000MHz



Tune capacitors to find a solution.

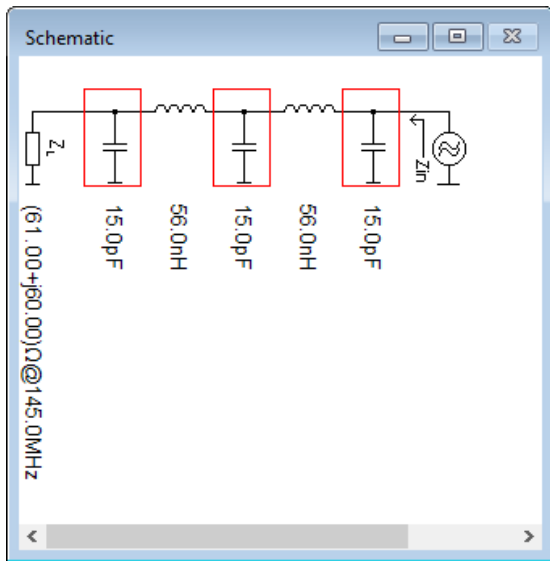

Tune dialog box showing three capacitor elements. Each element has a slider and input fields for Max, Value, and Min. The Max value is $1.8\text{E}-11$, the Value is 15.00pF , and the Min value is $1.2\text{E}-11$. Buttons for Remove, Reset Min/Max, Remove all, OK, and Help are visible.

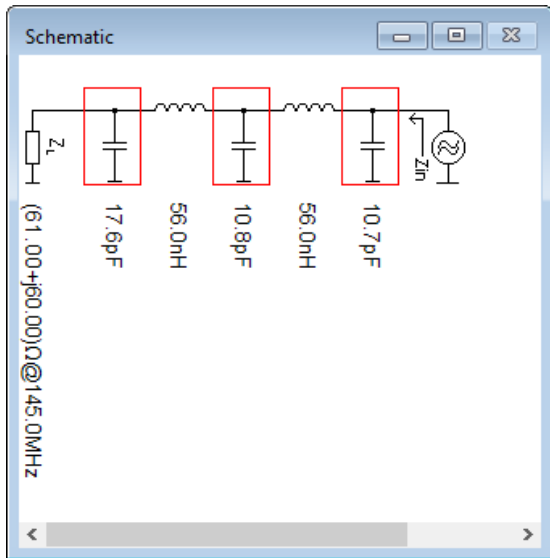

Tune dialog box showing three capacitor elements. Each element has a slider and input fields for Max, Value, and Min. The Max values are $2.11\text{E}-11$, $1.48\text{E}-11$, and $1.44\text{E}-11$. The Value values are 17.58pF , 10.80pF , and 10.70pF . The Min values are $1.406\text{E}-11$, $9.867\text{E}-12$, and $9.6\text{E}-12$. Buttons for Remove, Reset Min/Max, Remove all, OK, and Help are visible.

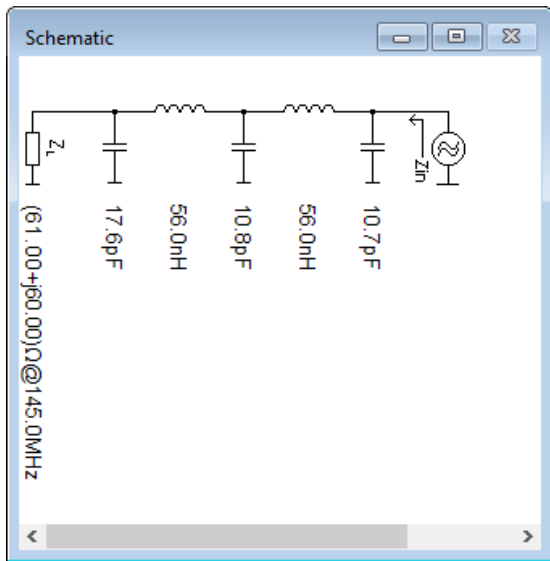
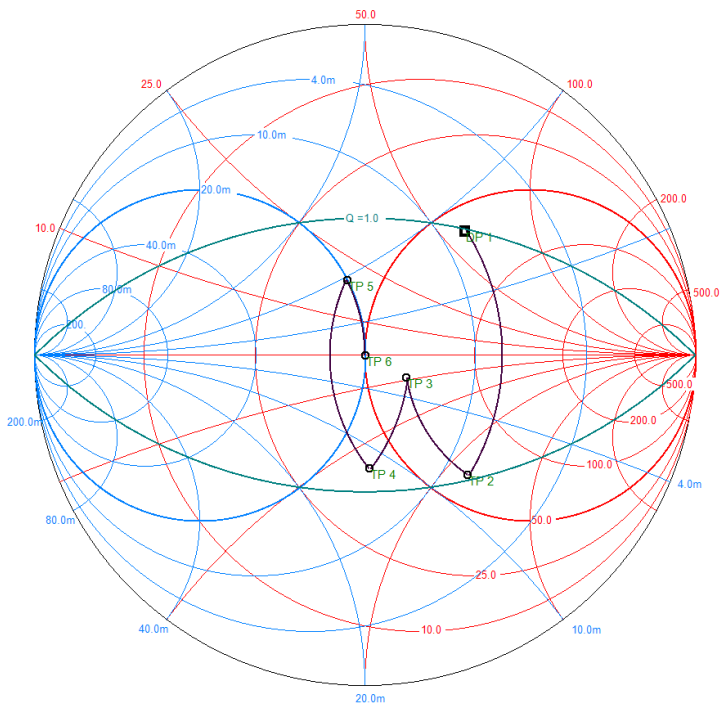

Start DP	Point	Z	Q	Frequency
<input checked="" type="checkbox"/>	DP 1	$(61.000 + j60.000)\ \Omega$	$Q=0.984$	145.000MHz
	TP 2	$(63.684 - j59.896)\ \Omega$	$Q=0.941$	145.000MHz
	TP 3	$(63.684 - j8.876)\ \Omega$	$Q=0.139$	145.000MHz
	TP 4	$(40.436 - j31.466)\ \Omega$	$Q=0.778$	145.000MHz
	TP 5	$(40.436 + j19.554)\ \Omega$	$Q=0.484$	145.000MHz
	TP 6	$(49.891 - j0.039)\ \Omega$	$Q=0.001$	145.000MHz

Many other solutions are possible.